

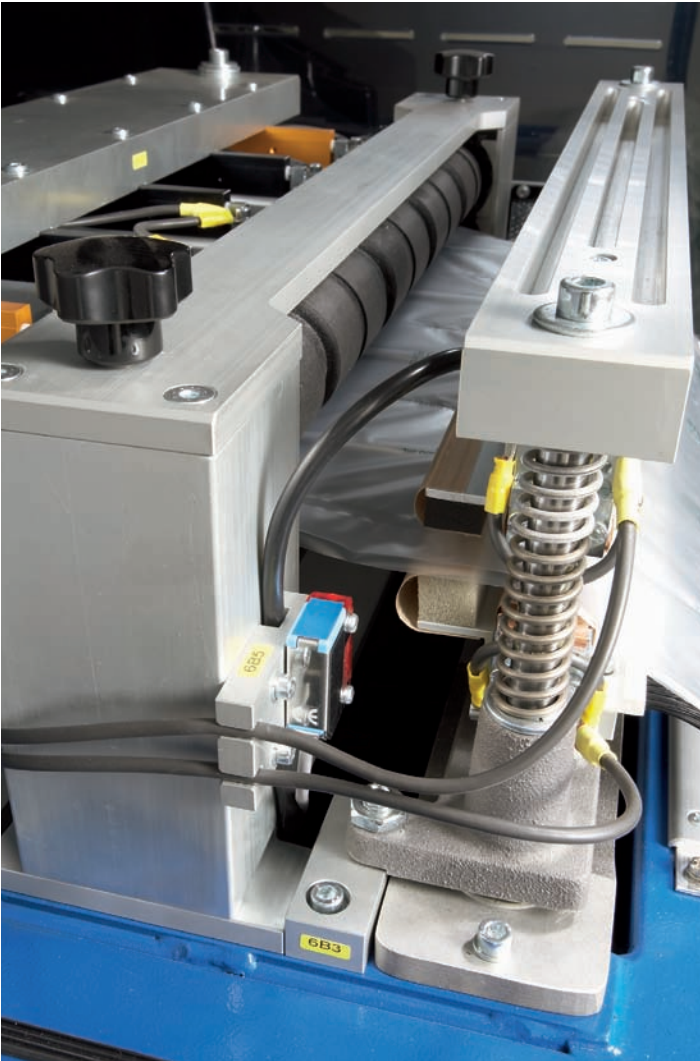

▼ The WL 170 miniature photoelectric reflex switch controls the presence of material for the production of air bubble film.

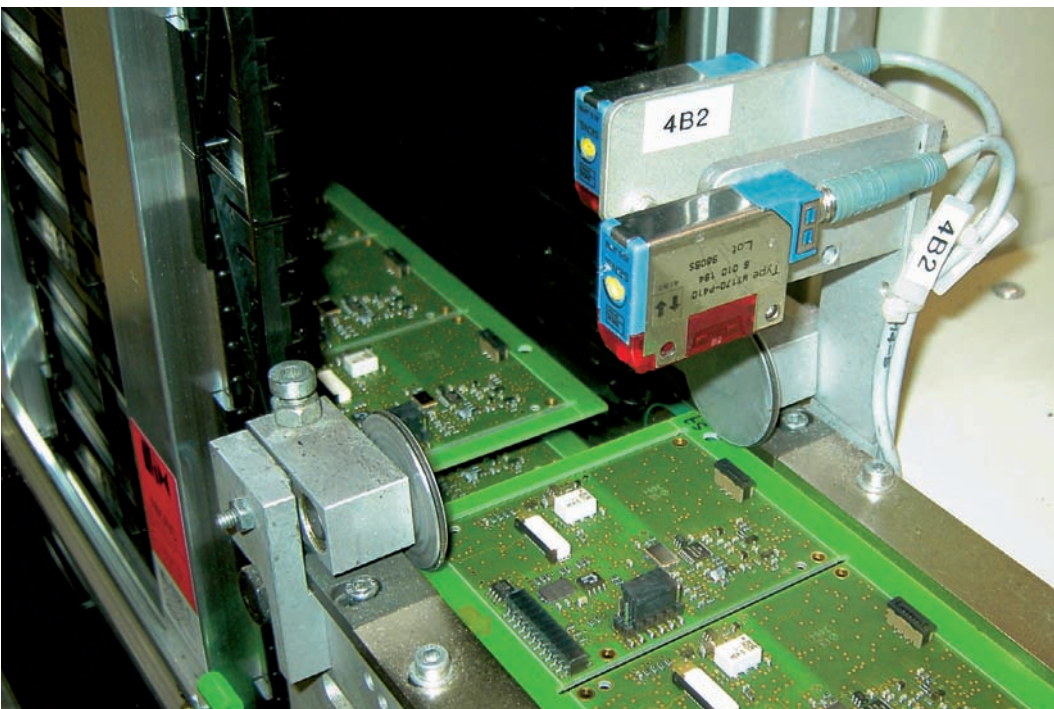

▲ The WS/WE 170 miniature through-beam photoelectric switch controlling the system timing of a plastic bag sealing machine. Polarising filter attachments allow block assembly.



◀ The WT 170 miniature photoelectric proximity switch supervises and controls supply of e-cards in a buffer store.

**Scanning distance**  
10...100 mm

Photoelectric proximity switches

- Focused sensor: with background blanking and high sensitivity
- Adjustable sensitivity (270°)
- Visible red light as alignment aid

Dimensional drawing

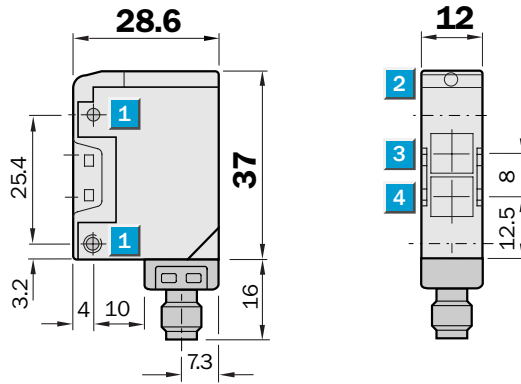

Adjustments possible

WT 170-P 112	WT 170-P 410
WT 170-N 112	WT 170-N 410

- 1 Mounting holes  $\varnothing$  3 mm with integrated M3 thread
- 2 LED signal strength indicator, red: light received  $\geq$  switching threshold
- 3 Centre of optical axis, receiver
- 4 Centre of optical axis, sender
- 5 Sensitivity control (potentiometer, 270°)

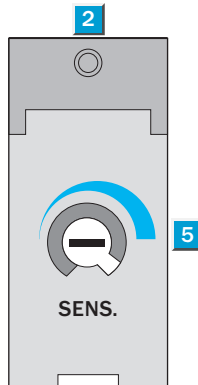

Connection types

WT 170-P 112	WT 170-P 410
WT 170-N 112	WT 170-N 410

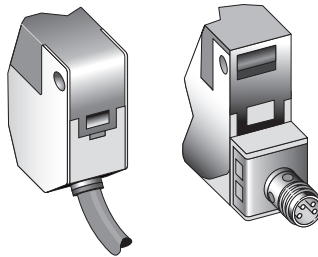

4 x 0.18 mm <sup>2</sup>	4-pin, M8
--------------------------	-----------

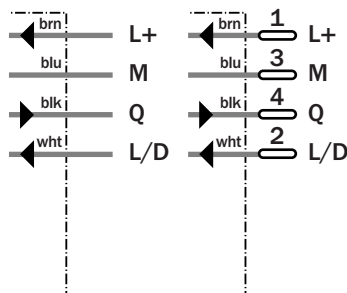

See chapter Accessories

Cables and connectors

Mounting systems \*)

\*) Mounting brackets included with delivery



Technical data		WT 170-	P 112	P 410	N 112	N 410						
<b>Scanning distance, max. typical</b>	10...100 mm <sup>1)</sup>											
<b>Operating distance</b>	10...90 mm <sup>1)</sup>											
Background suppression	From approx. 120 mm, Background, 90% remission											
Sensitivity	Potentiometer, 270° (adjustable)											
<b>Light source<sup>2)</sup>, light type</b>	LED, visible red light											
Light spot size	Approx. 3.5 mm at 40 mm											
Angle of dispersion, sender	Focused, focal point 40 mm											
<b>Supply voltage V<sub>S</sub></b>	10...30 V DC <sup>3)</sup>											
Ripple <sup>4)</sup>	± 10 %											
Current consumption <sup>5)</sup>	≤ 30 mA											
<b>Switching outputs</b>	PNP, open collector: Q NPN, open collector: Q											
Output current I <sub>A</sub> max.	100 mA											
Switching mode	Light-/dark-switch. via L/D control cable + V <sub>S</sub> = light-switching 0 V = dark-switching											
Response time <sup>6)</sup>	≤ 0.7 ms											
Max. switching frequency <sup>7)</sup>	700/s											
<b>Connection types</b>	cable PVC, 2 m <sup>8)</sup> ; 4 x 0.18 mm <sup>2</sup> , ø 3.8 mm plug M8, 4-pin											
<b>VDE protection class<sup>9)</sup></b>	□											
<b>Circuit protection<sup>10)</sup></b>	A, B, C, D											
<b>Enclosure rating</b>	IP 67											
<b>Ambient temperature T<sub>A</sub></b>	Operation - 25 °C...+ 55 °C Storage - 40 °C...+ 70 °C											
<b>Weight</b>	with cable 2 m Approx. 25 g with M8 plug, 4-pin Approx. 66 g											
<b>Housing material</b>	Housing: stainless steel/ABS; optics: PC											

- 1) Object with 90 % remission (based on standard white to DIN 5033)
- 2) Average service life 100,000 h at T<sub>A</sub> = + 25 °C
- 3) Limit values
- 4) May not exceed or fall short of V<sub>S</sub> tolerances
- 5) Without load
- 6) Signal transit time with resistive load
- 7) With light/dark ratio 1:1
- 8) Do not bend below 0 °C
- 9) Reference voltage 50 V DC
- 10) A = V<sub>S</sub> connections reverse-polarity protected  
B = Inputs and outputs reverse-polarity protected
- C = Interference pulse suppression  
D = Outputs overcurrent and short-circuit protected

**Scanning distance**

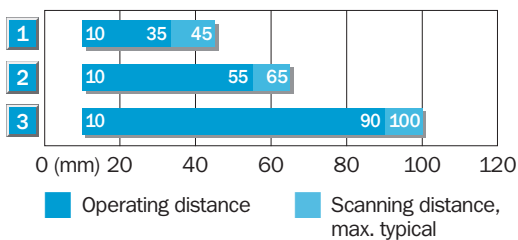

- 1 Scanning distance on black, 6 % remission
- 2 Scanning distance on grey, 18 % remission
- 3 Scanning distance on white, 90 % remission

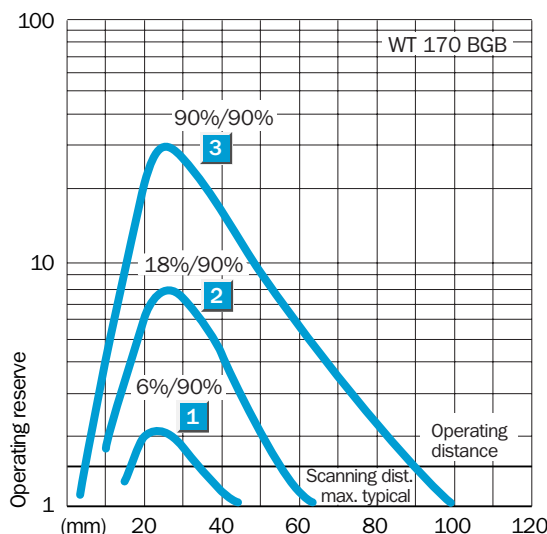

**Order information**

Type	Order no.
WT 170-P 112	6 010 193
WT 170-P 410	6 010 194
WT 170-N 112	6 010 195
WT 170-N 410	6 010 196

**Scanning distance**  
**10...550 mm**

Photoelectric proximity switches

- Energetic photoelectric proximity switch for standard applications
- Adjustable sensitivity
- Visible red light LED transmitter alignment aid

**Dimensional drawing**

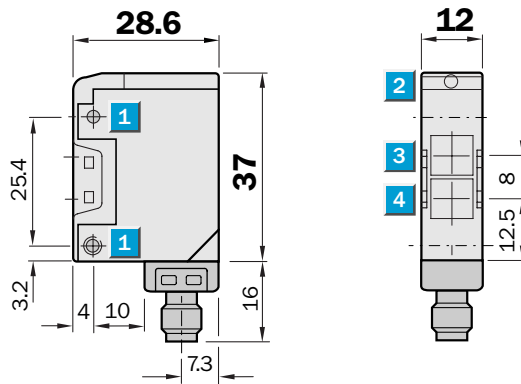

**Adjustments possible**

WT 170-P 132	WT 170-P 430
WT 170-N 132	WT 170-N 430

- 1 Mounting holes  $\varnothing$  3 mm with integrated M3 thread
- 2 LED signal strength indicator, red: light received  $\geq$  switching threshold
- 3 Centre of optical axis, receiver
- 4 Centre of optical axis, sender
- 5 Sensitivity control (potentiometer, 270°)

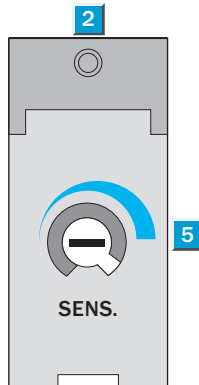

**Connection types**

WT 170-P 132	WT 170-P 430
WT 170-N 132	WT 170-N 430

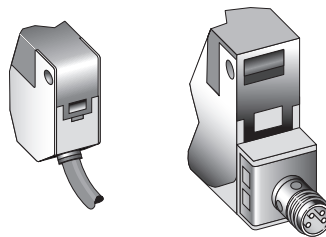

4 x 0.18 mm <sup>2</sup>	4-pin, M8
--------------------------	-----------

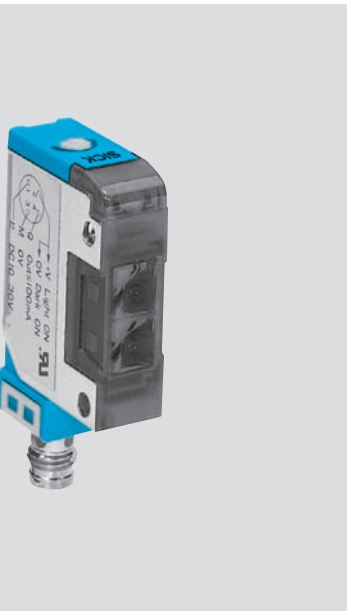
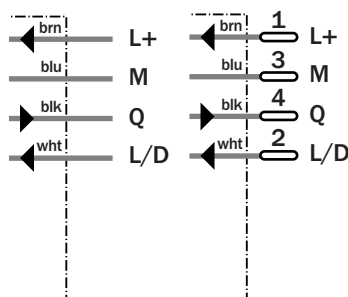

**See chapter Accessories**

Cables and connectors

Mounting systems \*)

\*) Mounting brackets included with delivery



Technical data		WT 170-	P 132	P 430	N 132	N 430						
Scanning distance, max. typical	10...550 mm <sup>1)</sup>											
Operating distance	10...400 mm <sup>1)</sup>											
Sensitivity	Adjustable											
Light source <sup>2)</sup> , light type	LED, visible red light											
Light spot size	Approx. 40 mm at 400 mm											
Angle of dispersion, sender	Approx. 5°											
Supply voltage V <sub>S</sub>	10...30 V DC <sup>3)</sup>											
Ripple <sup>4)</sup>	± 10 %											
Current consumption <sup>5)</sup>	≤ 30 mA											
Switching outputs	PNP, open collector: Q NPN, open collector: Q											
Output current I <sub>A</sub> max.	100 mA											
Switching mode	Light-/dark-switch. via L/D control cable + V <sub>S</sub> = light-switching 0 V = dark-switching											
Response time <sup>6)</sup>	≤ 0.7 ms											
Max. switching frequency <sup>7)</sup>	700/s											
Connection types	cable PVC, 2 m <sup>8)</sup> ; 4 x 0.18 mm <sup>2</sup> , ø 3.8 mm plug M8, 4-pin											
VDE protection class <sup>9)</sup>	□											
Circuit protection <sup>10)</sup>	A, B, C, D											
Enclosure rating	IP 67											
Ambient temperature T <sub>A</sub>	Operation - 25 °C...+ 55 °C Storage - 40 °C...+ 70 °C											
Weight	with cable 2 m Approx. 25 g with M8 plug, 4-pin Approx. 66 g											
Housing material	Housing: stainless steel/ABS; optics: PC											

- 1) Object with 90 % remission (based on standard white to DIN 5033)
- 2) Average service life 100,000 h at T<sub>A</sub> = + 25 °C
- 3) Limit values
- 4) May not exceed or fall short of V<sub>S</sub> tolerances
- 5) Without load
- 6) Signal transit time with resistive load
- 7) With light/dark ratio 1:1
- 8) Do not bend below 0 °C
- 9) Reference voltage 50 V DC
- 10) A = V<sub>S</sub> connections reverse-polarity protected  
B = Inputs and outputs reverse-polarity protected  
C = Interference pulse suppression  
D = Outputs overcurrent and short-circuit protected

Scanning distance		Order information	
1	10 80 130	Type	Order no.
2	10 200 250	WT 170-P 132	6 010 197
3	10 400 550	WT 170-P 430	6 010 198
		WT 170-N 132	6 010 199
		WT 170-N 430	6 010 200

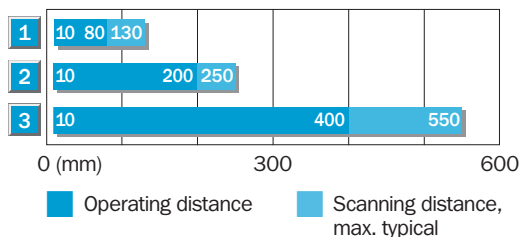

- 1 Scanning distance on black, 6 % remission
- 2 Scanning distance on grey, 18 % remission
- 3 Scanning distance on white, 90 % remission

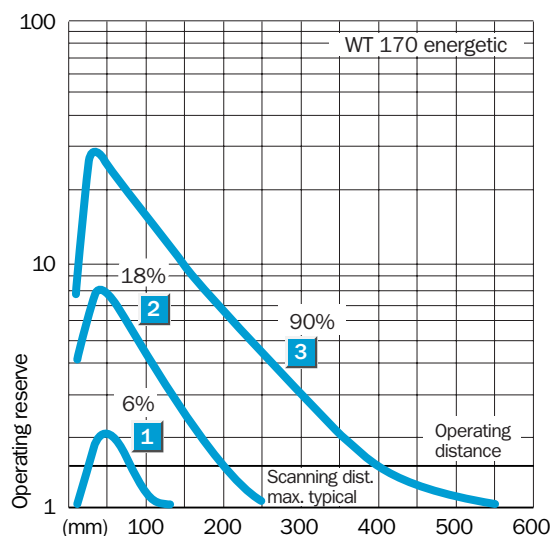

	<b>Scanning range</b> 0.01...4.0 m
<b>Photoelectric reflex switches</b>	

- Polarising filter enabling reliable detection of objects with shiny surfaces
- Also suitable for “Diamond Grade” reflective tape
- Visible red light LED transmitter as alignment aid

**Dimensional drawing**

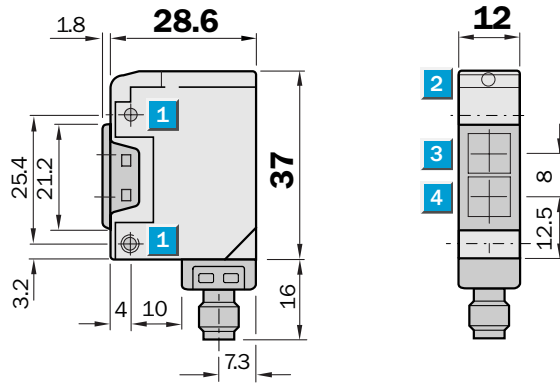

- 1** Mounting holes  $\varnothing$  3 mm with integrated M3 thread
- 2** LED signal strength indicator, red:  
light received  $\geq$  switching threshold
- 3** Centre of optical axis, receiver
- 4** Centre of optical axis, sender

**Connection types**

WL 170-P 132	WL 170-P 430
WL 170-N 132	WL 170-N 430

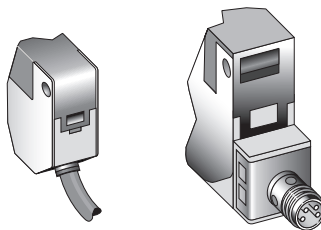

4 x 0.18 mm <sup>2</sup>	4-pin, M8
--------------------------	-----------

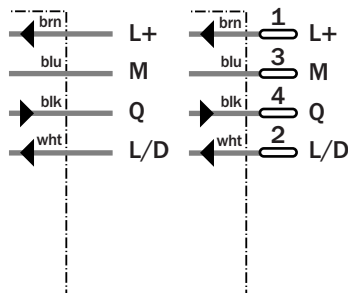

<b>See chapter Accessories</b>
Cables and connectors
Mounting systems *)
Reflectors **)

\*) Mounting brackets included with delivery  
 \*\*) Reflector P 250 included with delivery

Technical data		WL 170-	P 132	P 430	N 132	N 430
<b>Scanning range, max. typical/</b> on reflector	0.01...4 m/PL 80 A 0.01...3 m/P 250 (included)					
<b>Operating range</b>	0.01...2.5 m/P 250					
<b>Light source<sup>1)</sup>, light type</b>	LED, visible red light with polarising filter					
Light spot size	Approx. 200 mm at 2.5 mm					
Angle of dispersion, sender	Approx. 2.7°					
<b>Supply voltage V<sub>S</sub></b>	10...30 V DC <sup>3)</sup>					
Ripple <sup>3)</sup>	± 10 %					
Current consumption <sup>4)</sup>	≤ 30 mA					
<b>Switching outputs</b>	PNP, open collector: Q NPN, open collector: Q					
Output current I <sub>A</sub> max.	100 mA					
Switching mode	Light-/dark-switch. via L/D control cable + V <sub>S</sub> = light-switching 0 V = dark-switching					
Response time <sup>5)</sup>	≤ 0.7 ms					
Max. switching frequency <sup>6)</sup>	700/s					
<b>Connection types</b> cable	PVC, 2 m <sup>7)</sup> ; 4 x 0.18 mm <sup>2</sup> , ø 3.8 mm					
plug	M8, 4-pin					
<b>VDE protection class<sup>8)</sup></b>	□					
<b>Circuit protection<sup>9)</sup></b>	A, B, C, D					
<b>Enclosure rating</b>	IP 67					
<b>Ambient temperature T<sub>A</sub></b>	Operation - 25 °C...+ 55 °C Storage - 40 °C...+ 70 °C					
<b>Weight</b> with cable 2 m	Approx. 25 g					
with M8 plug, 4-pin	Approx. 66 g					
<b>Housing material</b>	Housing: stainless steel/ ABS; optics: PMMA					

- 1) Average service life 100,000 h at T<sub>A</sub> = + 25 °C
- 2) Limit values
- 3) May not exceed or fall short of V<sub>S</sub> tolerances
- 4) Without load
- 5) Signal transit time with resistive load
- 6) With light/dark ratio 1:1
- 7) Do not bend below 0 °C
- 8) Reference voltage 50 V DC
- 9) A = V<sub>S</sub> connections reverse-polarity protected  
B = Inputs and outputs reverse-polarity protected  
C = Interference pulse suppression  
D = Outputs overcurrent and short-circuit protected

**Scanning range and operating reserve**

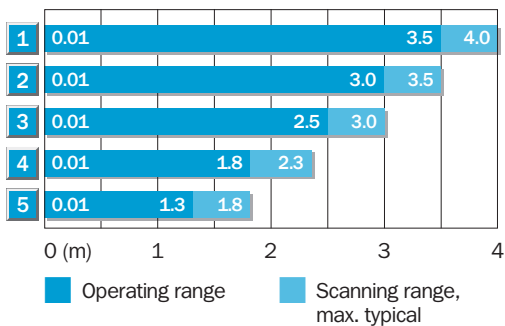

Reflector type	Operating range
1 PL 80 A	0.01 – 3.5 m
2 PL 50 A	0.01 – 3.0 m
PL 40 A	0.01 – 3.0 m
3 P 250	0.01 – 2.5 m
PL 30 A	0.01 – 2.5 m
PL 31	0.01 – 2.5 m
4 PL 20	0.01 – 1.8 m
5 Reflective tape	0.01 – 1.3 m
«Diamond Grade» 90 x 90 mm	

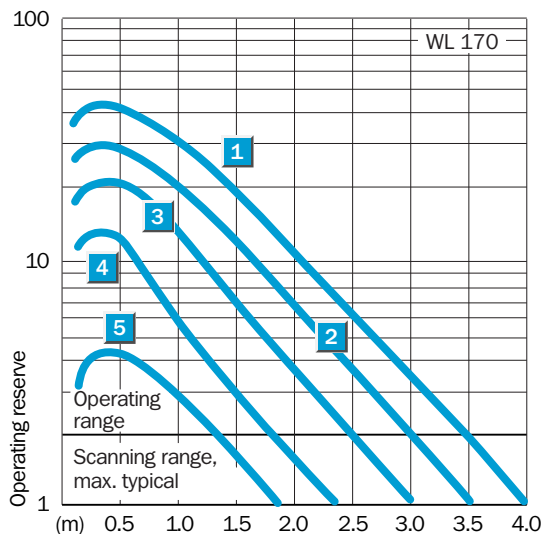

**Order information**

Type	Order no.
WL 170-P 132	6 010 189
WL 170-P 430	6 010 190
WL 170-N 132	6 010 191
WL 170-N 430	6 010 192



**Scanning range**  
**0.1...0.8 m**  
 Photoelectric reflex switches

- Ideal for the detection of glass, transparent objects or small parts
- Detection reliability:  
Min. attenuation 20 %;  
Min. transmission variation 15 %,  
Adjustable sensitivity
- Focused optics

**Dimensional drawing**

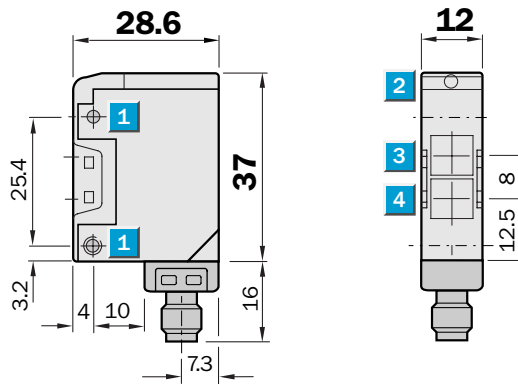

**Adjustments possible**

WL 170-P 122	WL 170-P 420
WL 170-N 122	WL 170-N 420

- 1 Mounting holes  $\varnothing$  3 mm with integrated M3 thread
- 2 LED signal strength indicator, red: light received  $\geq$  switching threshold
- 3 Centre of optical axis, receiver
- 4 Centre of optical axis, sender
- 5 Sensitivity control (potentiometer, 270°)

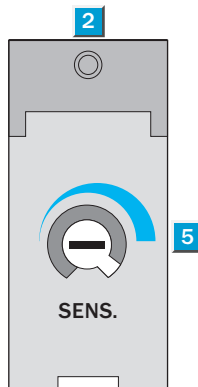

**Connection types**

WL 170-P 122	WL 170-P 420
WL 170-N 122	WL 170-N 420

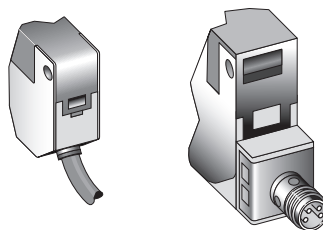

4 x 0.18 mm <sup>2</sup>	4-pin, M8
--------------------------	-----------

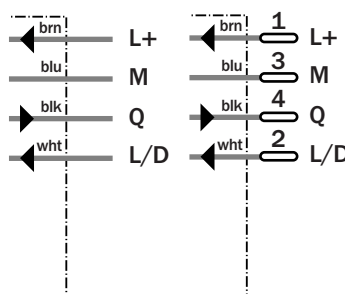

<b>See chapter Accessories</b>
Cables and connectors
Mounting systems *)
Reflectors **)

\*) Mounting brackets included with delivery  
 \*\*) Reflector P 250 included with delivery

Technical data		WL 170-	P 122	P 420	N 122	N 420
<b>Detection of transparent objects</b>						
Attenuation along light beam	min. 20 %					
Attenuation difference	min. 15 %					
Sensitivity	Potentiometer, 270° (adjustable)					
<b>Scanning range, max. typical/</b>	0.1...0.8 m/PL 80 A					
on reflector	0.1...0.6 m/P 250 (included)					
<b>Operating range</b>	0.1...0.5 m/P 250					
	Reflective tape: not suitable					
<b>Light source<sup>1)</sup>, light type</b>						
	LED, visible red light					
Light spot size	Approx. 30 mm at 0.5 m					
Angle of dispersion, sender	Focused: $\phi$ approx. 5 mm where SR = 90 mm					
<b>Supply voltage <math>V_S</math></b>						
	10...30 V DC <sup>3)</sup>					
Ripple <sup>3)</sup>	$\pm 10 \%$					
Current consumption <sup>4)</sup>	$\leq 30$ mA					
<b>Switching outputs</b>						
	PNP, open collector: Q					
	NPN, open collector: Q					
Output current $I_A$ max.	100 mA					
Switching mode	Light-/dark-switch. via L/D control cable					
	+ $V_S$ = light-switching					
	0 V = dark-switching					
Response time <sup>5)</sup>	$\leq 0.7$ ms					
Max. switching frequency <sup>6)</sup>	700/s					
<b>Connection types</b>						
cable	PVC, 2 m <sup>7)</sup> ; 4 x 0.18 mm <sup>2</sup> , $\phi$ 3.8 mm					
plug	M8, 4-pin					
<b>VDE protection class<sup>8)</sup></b>						
	<input type="checkbox"/>					
<b>Circuit protection<sup>9)</sup></b>						
	A, B, C, D					
<b>Enclosure rating</b>						
	IP 67					
<b>Ambient temperature <math>T_A</math></b>						
	Operation - 25 °C...+ 55 °C					
	Storage - 40 °C...+ 70 °C					
<b>Weight</b>						
with cable 2 m	Approx. 25 g					
with M8 plug, 4-pin	Approx. 66 g					
<b>Housing material</b>						
	Housing: stainless steel/ABS; optics: PC					

1) Average service life 100,000 h at  $T_A = +25$  °C

2) Limit values

3) May not exceed or fall short of  $V_S$  tolerances

4) Without load

5) Signal transit time with resistive load

6) With light/dark ratio 1:1

7) Do not bend below 0 °C

8) Reference voltage 50 V DC

9) A =  $V_S$  connections reverse-polarity protected

B = Inputs and outputs reverse-polarity protected

C = Interference pulse suppression  
D = Outputs overcurrent and short-circuit protected

**Scanning range and operating reserve**

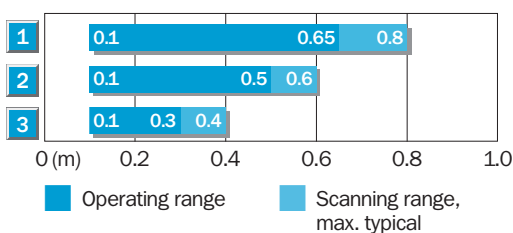

Reflector type	Operating range
1 PL 80 A	0.1...0.65 m
2 P 250	0.1...0.5 m
3 PL 20 A	0.1...0.3 m

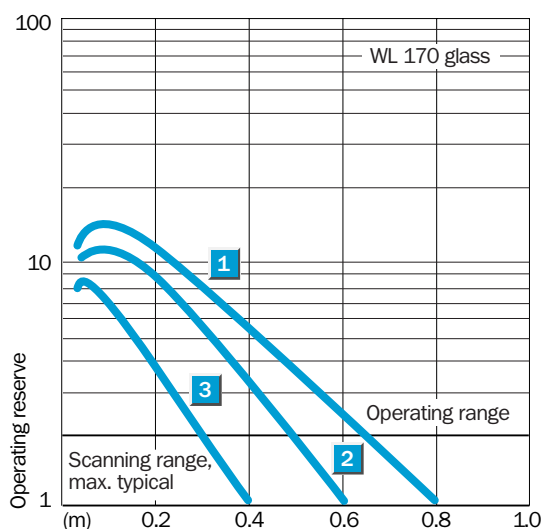

**Order information**

Type	Order no.
WL 170-P 122	6 010 185
WL 170-P 420	6 010 186
WL 170-N 122	6 010 187
WL 170-N 420	6 010 188

**Scanning range**  
8.5 m

Through-beam photoelectric switches

- Polarising filter attachments (accessories) to reduce mutual interference if several WS/WE 170 units are used
- Test input (WS 170 sender) for device and system testing
- Slotted masks (1 mm) to detect small parts or for positioning tasks

**Dimensional drawing**

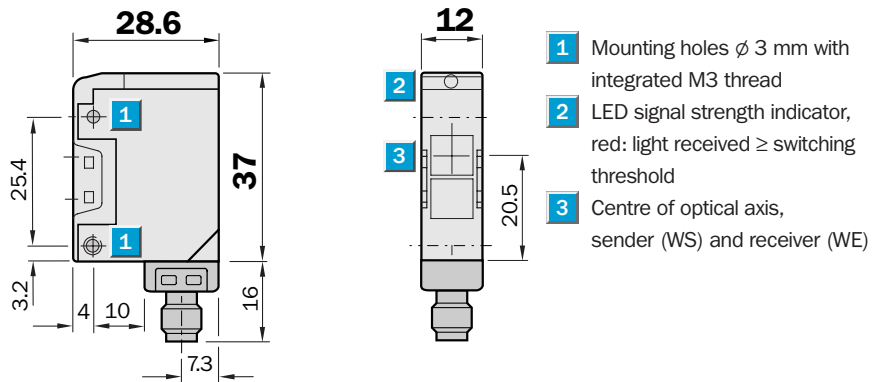

**Minimum distance  $D_{min.}$  between sides of two WS/WE 170 units**

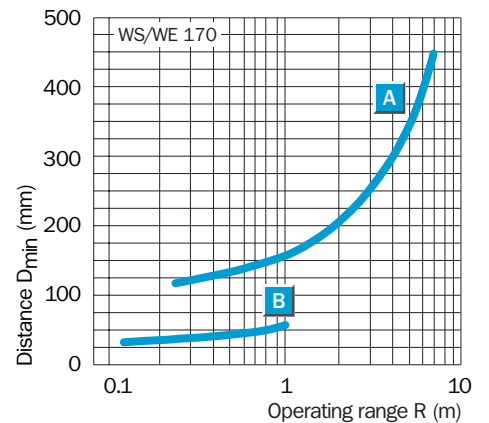
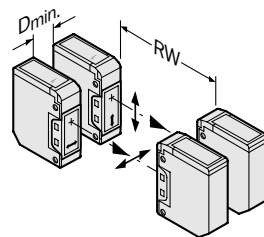

**Prevention of mutual interference with two WS/WE 170 units**

Minimum distance  $D_{min.}$  observed for:

- A R 0.25 m ... 7 m: without optical attachments
- B R 0.15 m ... 1 m: with slotted masks BL170-10

No mutual interference if polarising filters are used

- C Polarising filter attachments BL170-POLF up to  $R \leq 3$  m only
- D Polarising filter BL170-POLF and slotted masks BL170-10 up to  $R \leq 0.5$  m



**Connection types**

WS/WE170-P 132	WS/WE170-P 430
WS/WE170-N 132	WS/WE170-N 430



**See chapter Accessories**

Cables and connectors

Mounting systems \*)

Special accessories

\*) Mounting brackets included with delivery

3 x 0.18 mm <sup>2</sup> Sender	4 x 0.18 mm <sup>2</sup> Receiver	4-pin, M8 Sender	4-pin, M8 Receiver

Technical data		WS/WE 170-	P 132	P 430	N 132	N 430
<b>Scanning range, max. typical</b>	8.5 m					
<b>Operating range</b>	7 m					
<b>Light source<sup>1)</sup>, light type</b>	LED, red light					
Light spot size	Approx. 850 mm at 7 m					
Angle of dispersion, sender	Approx. 7°					
Angle of dispersion, receiver	Approx. 20°					
<b>Supply voltage V<sub>S</sub></b>	10...30 V DC <sup>2)</sup>					
Ripple <sup>3)</sup>	± 10 %					
Current consumption <sup>4)</sup> sender	≤ 20 mA					
receiver	≤ 30 mA					
<b>Switching outputs</b>	PNP, open collector: Q					
	NPN, open collector: Q					
Output current I <sub>A</sub> max.	100 mA					
Switching mode	Light-/dark-switch. via L/D control cable					
	+ V <sub>S</sub> = light-switching					
	0 V = dark-switching					
Response time <sup>5)</sup>	≤ 1.0 ms					
Max. switching frequency <sup>6)</sup>	500/s					
<b>Test input "TE"</b> sender OFF	PNP, NPN: TE to 0 V					
<b>Connection types</b> cable	PVC, 2 m <sup>7)</sup>					
sender WS	3 x 0.18 mm <sup>2</sup> , ø 3.8 mm					
receiver WE	4 x 0.18 mm <sup>2</sup> , ø 3.8 mm					
plug	M8, 4-pin					
<b>VDE protection class<sup>8)</sup></b>	□					
<b>Circuit protection<sup>9)</sup></b>						
sender	A, B					
receiver	A, B, C, D					
<b>Enclosure rating</b>	IP 67					
<b>Ambient temperature T<sub>A</sub></b>	Operation - 25 °C...+ 55 °C					
	Storage - 40 °C...+ 70 °C					
<b>Weight</b> with cable 2 m	Sender: approx. 66 g					
	Receiver: approx. 66 g					
with M8 plug, 4-pin	Sender: approx. 25 g					
	Receiver: approx. 25 g					
<b>Housing material</b>	Housing: stainless steel/ABS; optics: PC					

- 1) Average service life 100,000 h at T<sub>A</sub> = + 25 °C
- 2) Limit values
- 3) May not exceed or fall short of V<sub>S</sub> tolerances
- 4) Without load
- 5) Signal transit time with resistive load
- 6) With light/dark ratio 1:1
- 7) Do not bend below 0 °C
- 8) Reference voltage 50 V DC
- 9) A = V<sub>S</sub> connections reverse-polarity protected  
B = Inputs and outputs reverse-polarity protected  
C = Interference pulse suppression  
D = Outputs overcurrent and short-circuit protected

**Scanning range and operating reserve**

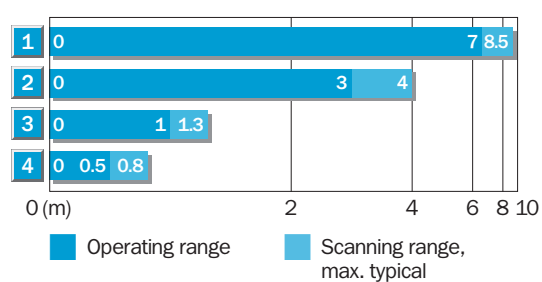

- 1 Without attachments
- 2 With polarising filter attachment
- 3 With slotted mask, 1 mm
- 4 With polarising filter and slotted mask, 1 mm

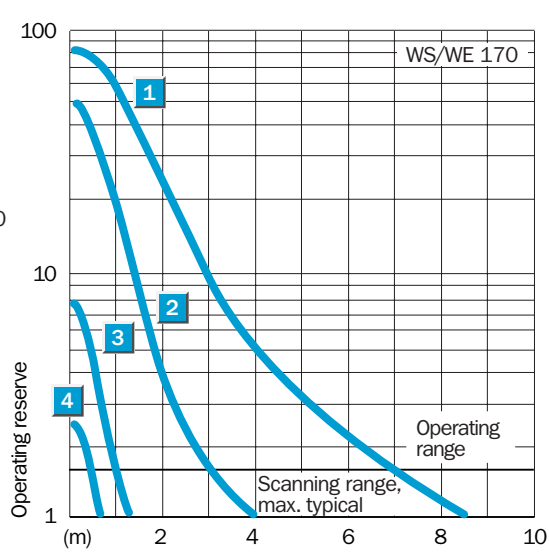

Order information	
Type	Order no.*
WS/WE170-P132	6 010 181
WS/WE170-N132	6 010 183
WS/WE170-P430	6 010 182
WS/WE170-N430	6 010 184

\* Order no. includes sender and receiver