

W 160: Miniature Series for Optimum Solutions



W 160 are especially well-suited for use in the branches:

- Electronic components and circuit board manufacturing
- Packaging and printing industry
- Assembly and handling technology
- Special mechanical engineering
- Conveyor technology.

The ranges:

- Through-beam photoelectric switch WS/WE 160: 14 m, 3 slotted masks as accessory
- Photoelectric reflex switch WL 160: 6 m (PL 80 A), with polarizing filter
- Photoelectric proximity switch WT 160: energetic: scanning distance to 900 mm (90% reflectance), for standard scanning jobs. With focussed optics: Scanning distance 8 to 55 mm, background suppression, small light spot, high sensitivity. With divergent optics (opening angle approx. 40°): scanning distance to 105 mm. Ideal for transparent objects.

	Photoelectric proximity switches
	Photoelectric reflex switches
	Through-beam photoelectric switches
	Photoelectric fiber-optic switches (scanner)
	Photoelectric fiber-optic switches (through-beam)

S Simple handling, large scanning distances, reduced number of types thanks to integrated L.ON/D.ON switches are system focal points.

All W 160 optics variants are available in two housing models with axial or 90° light emission. The WLL 160 photoelectric switch for fiber-optic cables with switching point setting, manually per potentiometer or automatically per Teach-In at the push of a button, rounds out the W 160 series. Plastic fiber-optic cables of the LL 3 series in approx. 50 different options are available as accessories.

Scanning distance
4... 55 mm

Photoelectric proximity switch

- Horizontal and vertical models
- Focussed scanner with background suppression and great sensitivity
- Contamination control with green LED indicator and contamination control output

Dimensional drawing

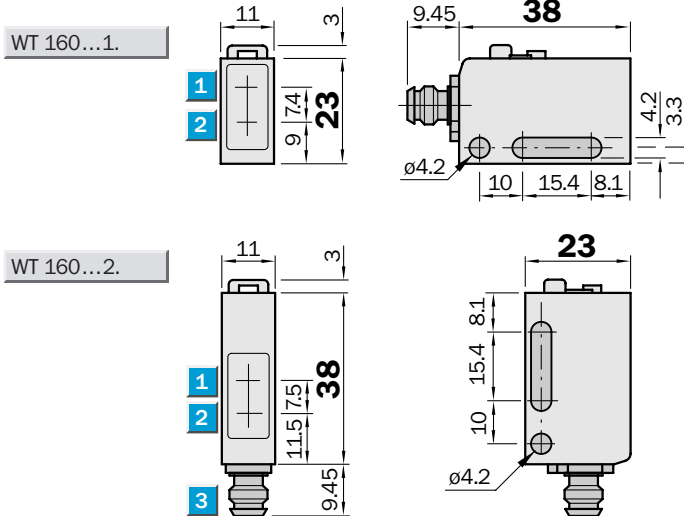

Setting options

All types

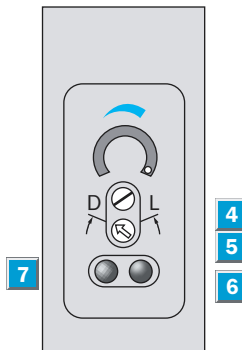

- 1 Optics center, receiver
- 2 Optics center, transmitter
- 3 Plug M 8 or connection cable
- 4 Sensitivity control
- 5 Light/dark rotary switch:
L = light switching
D = dark switching
- 6 Orange LED indicator (Status output)
- 7 Green LED signal strength indicator (Operating reserve)



Connection type

WT 160-E112	WT 160-E310	WT 160-E410
WT 160-E122	WT 160-E320	WT 160-E420
WT 160-F112	WT 160-F310	WT 160-F410
WT 160-F122	WT 160-F320	WT 160-F420

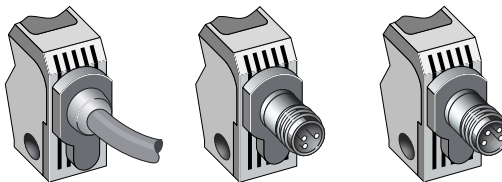

3x0.2 mm²

3 pin, M8

4 pin, M8

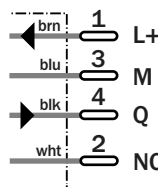
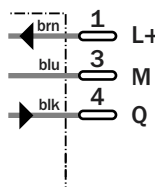
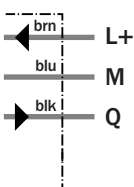

Accessories

Cable receptacles

Mounting bracket (included)

NC = not connected

Specifications		WT 160-	F112	F310	F410	E112	E310	E410	F122	F320	F420	E122	E320	E420
Housing shape	Horizontal													
	Vertical													
Scanning distance, typ. max.	4 ... 55 mm ¹⁾													
Operating scanning distance	8 ... 50 mm ¹⁾													
Background suppression	From approx. 100 mm													
Adjustable sensitivity	Potentiometer, 2 rotations w. scaling 270°													
Light source ²⁾ , light type	LED, red light													
Light spot diameter	Approx. 3 mm at 25 mm distance													
Transmitter dispersion angle	Focussed, focus 25 mm													
Supply voltage V _S	DC 10 ... 30 V ³⁾													
Residual ripple ⁴⁾	± 10 %													
Current consumption ⁵⁾	≤ 25 mA													
Switching outputs	PNP, open collector: Q NPN, open collector: Q													
Output current I _A max.	100 mA													
Light receiver, switching type	Light/dark switching per rotary switch													
Response time ⁶⁾ /Max. switching frequ. ⁷⁾	≤ 0.5 ms / 1000/s													
Connection type: connection cable	PVC, 2 m ⁸⁾ ; 3 x 0.2 mm ² , ø 4.2 mm													
plug	3 pin, M8													
plug	4 pin, M8													
VDE protection class ⁹⁾	□													
Protection circuits ¹⁰⁾	A, B, C, D													
Enclosure rating	IP 67													
Ambient temperature	Operation - 25... + 55 °C Storage - 40 ... + 70 °C													
Weight	With connection cable approx. 60 g With plug approx. 20 g													
Housing material	Housing: PBT; optics: PMMA													

- 1) Scanned material with 90 % reflectance (with reference to standard white according to DIN 5033)
- 2) Average service life 100,000 h at T_U = + 25 °C

- 3) Limit values
- 4) May not exceed or fall short of V_S tolerances
- 5) Without load

- 6) Signal operating time with ohmic load
- 7) With light/dark ratio 1:1
- 8) Do not bend connection cable below 0 °C
- 9) Rated voltage DC 50 V

- 10) A = V_S connections reverse-polarity protected
- B = Inputs and outputs reverse-polarity protected
- C = Interference pulse suppression
- D = Outputs overload and short-circuit protected

Scanning distance

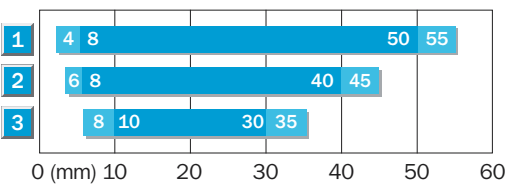

■ Operating scanning distance
■ Typ. max. scanning distance

- 1 Scanning range on white, 90 % reflectance
- 2 Scanning range on gray, 18 % reflectance
- 3 Scanning range on black, 6 % reflectance

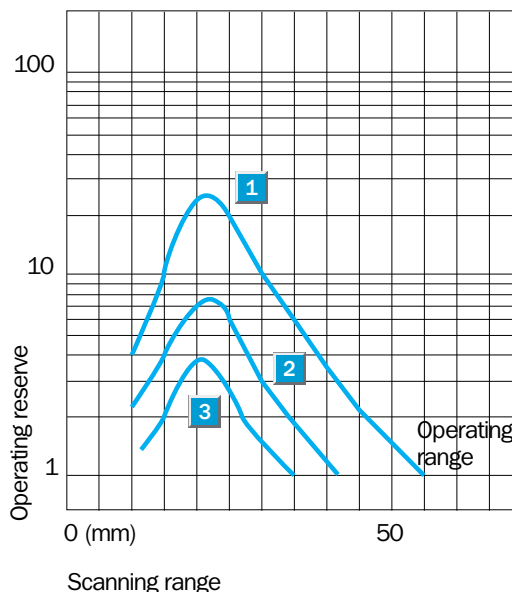

Ordering information

Type	Order no.
WT 160-F112	6 022 783
WT 160-F310	6 022 787
WT 160-F410	6 022 788
WT 160-F122	6 022 785
WT 160-F320	6 022 789
WT 160-F420	6 022 790
WT 160-E112	6 022 775
WT 160-E310	6 022 779
WT 160-E410	6 022 780
WT 160-E122	6 022 777
WT 160-E320	6 022 781
WT 160-E420	6 022 782

Scanning distance
0 ... 900 mm

Photoelectric proximity switch

- Horizontal and vertical models
- Energetic scanner for standard applications
- Contamination control with green LED indicator and contamination control output

Dimensional drawing

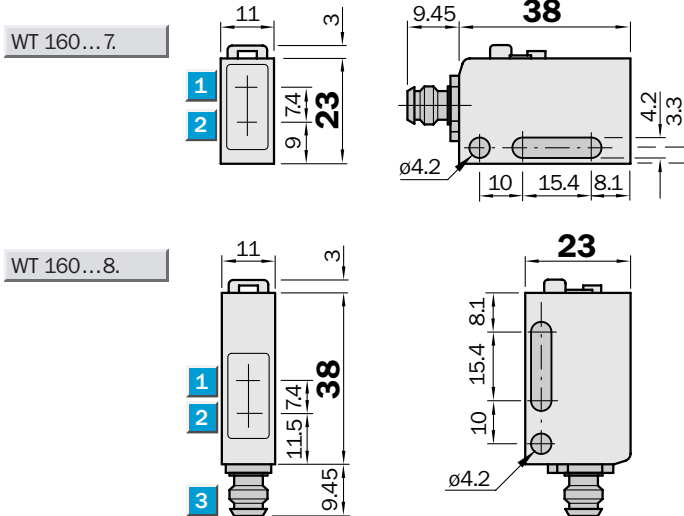

Setting options

All types

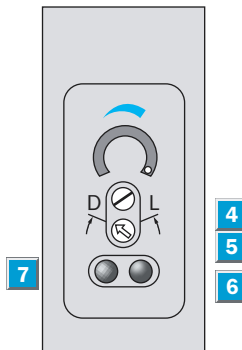

- 1 Optics center, receiver
- 2 Optics center, transmitter
- 3 Plug M 8 or connection cable
- 4 Sensitivity control
- 5 Light/dark rotary switch:
L = light switching
D = dark switching
- 6 Orange LED indicator (Status output)
- 7 Green LED signal strength indicator (Operating reserve)



Connection type

WT 160-E172	WT 160-E370	WT 160-E470
WT 160-E182	WT 160-E380	WT 160-E480
WT 160-F172	WT 160-F370	WT 160-F470
WT 160-F182	WT 160-F380	WT 160-F480

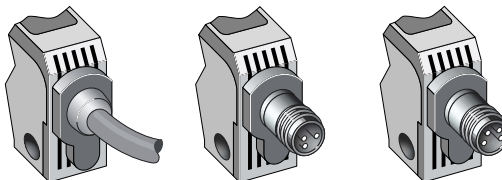

3x0.2 mm²

3 pin, M8

4 pin, M8

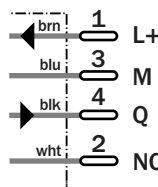
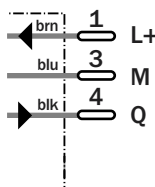
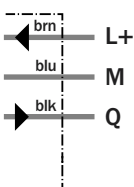

Accessories

Cable receptacles

Mounting bracket (included)

NC = not connected

Specifications		WT 160-	F172	F370	F470	E172	E370	E470	F182	F380	F480	E182	E380	E480
Housing shape	Horizontal													
	Vertical													
Scanning distance, typ. max.	0 ... 900 mm ¹⁾													
Operating scanning distance	0 ... 800 mm ¹⁾													
Adjustable sensitivity	Potentiometer, 2 rotations w. scaling 270°													
Light source ²⁾ , light type	LED, red light													
Light spot diameter	Approx. 90 mm at 500 mm distance													
Transmitter dispersion angle	Approx. 4.8°													
Supply voltage V _S	DC 10 ... 30 V ³⁾													
Residual ripple ⁴⁾	± 10 %													
Current consumption ⁵⁾	≤ 25 mA													
Switching outputs	PNP, open collector: Q NPN, open collector: Q													
Output current I _A max.	100 mA													
Light receiver, switching type	Light/dark switching per rotary switch													
Response time ⁶⁾ / Max. switching frequ ⁷⁾	≤ 0.5 ms / 1000/s													
Connection type: connection cable	PVC, 2 m ⁸⁾ ; 3 x 0.2 mm ² , ø 4.2 mm													
plug	3 pin, M8													
plug	4 pin, M8													
VDE protection class ⁹⁾	□													
Protection circuits ¹⁰⁾	A, B, C, D													
Enclosure rating	IP 67													
Ambient temperature	Operation - 25... +55 °C Storage - 40... +70 °C													
Weight	With connection cable approx. 60 g With plug approx. 20 g													
Housing material	Housing: PBT; optics: PMMA													

- 1) Scanned material with 90 % reflectance (with reference to standard white according to DIN 5033)
- 2) Average service life 100,000 h at T_U = +25 °C

- 3) Limit values
- 4) May not exceed or fall short of V_S tolerances
- 5) Without load
- 6) Signal operating time with ohmic load

- 7) With light/dark ratio 1:1
- 8) Do not bend connection cable below 0 °C
- 9) Rated voltage DC 50 V

- 10) A = V_S connections reverse-polarity protected
- B = Inputs and outputs reverse-polarity protected
- C = Interference pulse suppression
- D = Outputs overload and short-circuit protected

Scanning distance

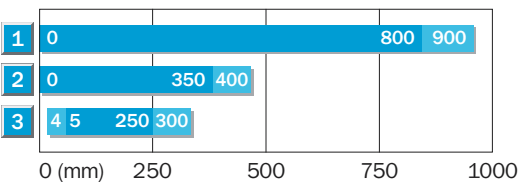

- Operating scanning distance
- Typ. max. scanning distance

1	Scanning range on white, 90 % reflectance
2	Scanning range on gray, 18 % reflectance
3	Scanning range on black, 6 % reflectance

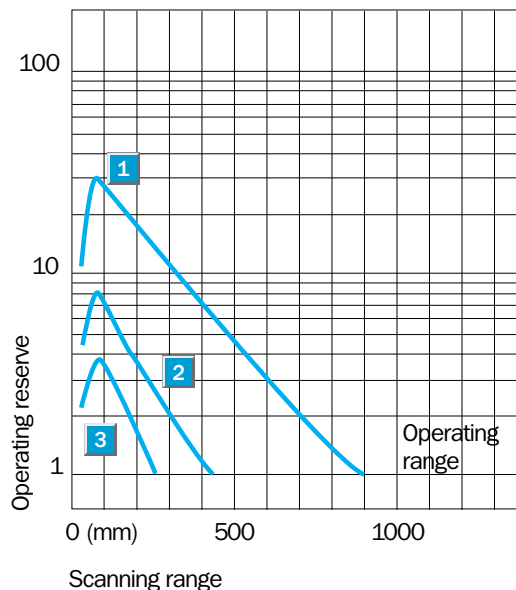

Ordering information

Type	Order no.
WT 160-F172	6 022 815
WT 160-F370	6 022 819
WT 160-F470	6 022 820
WT 160-F182	6 022 817
WT 160-F380	6 022 821
WT 160-F480	6 022 822
WT 160-E172	6 022 807
WT 160-E370	6 022 811
WT 160-E470	6 022 812
WT 160-E182	6 022 809
WT 160-E380	6 022 813
WT 160-E480	6 022 814



Scanning distance
0...105 mm
 Photoelectric proximity switch

- Horizontal and vertical models
- Scanner with large opening angle for detecting objects conveyed loosely
- Contamination control with green LED indicator and contamination control output

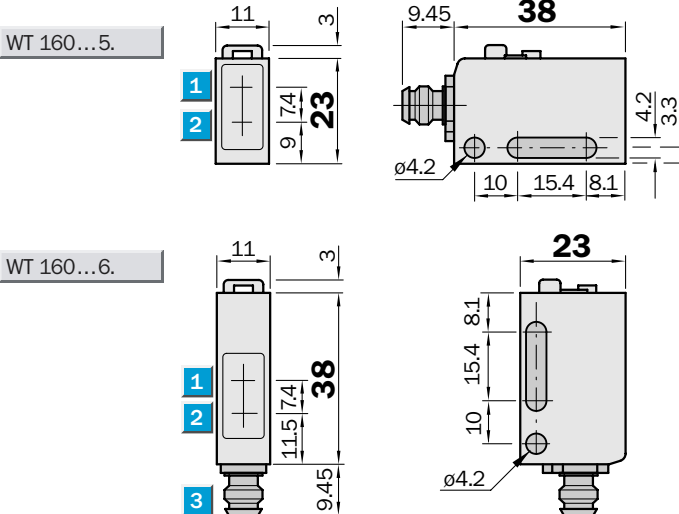
Dimensional drawing

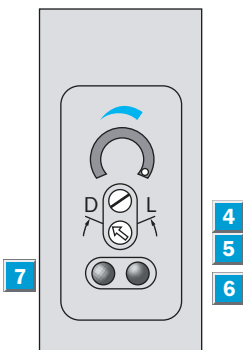

Setting options
All types



- 1 Optics center, receiver
- 2 Optics center, transmitter
- 3 Plug M 8 or connection cable
- 4 Sensitivity control
- 5 Light/dark rotary switch:
L = light switching
D = dark switching
- 6 Orange LED indicator (Status output)
- 7 Green LED signal strength indicator (Operating reserve)



Connection type		
WT 160-E152	WT 160-E350	WT 160-E450
WT 160-E162	WT 160-E360	WT 160-E460
WT 160-F152	WT 160-F350	WT 160-F450
WT 160-F162	WT 160-F360	WT 160-F460

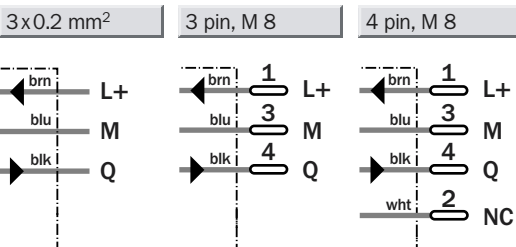
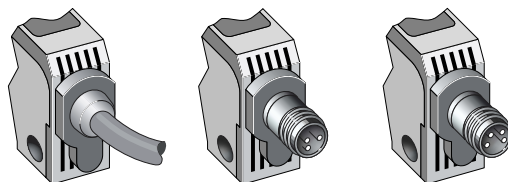

Accessories

Cable receptacles
Mounting bracket (included)

NC = not connected

Specifications		WT 160-	F152	F350	F450	E152	E350	E450	F162	F360	F460	E162	E360	E460
Housing shape	Horizontal													
	Vertical													
Scanning distance, typ. max.	0 ... 105 mm ¹⁾²⁾													
Operating scanning distance	0 ... 100 mm ¹⁾²⁾													
Adjustable sensitivity	Potentiometer, 2 rotations w. scaling 270°													
Light source ³⁾ , light type	LED, red light													
Light spot diameter	Approx. 100 mm at 100 mm distance													
Transmitter dispersion angle	Approx. 40°													
Supply voltage V_S	DC 10 ... 30 V ⁴⁾													
Residual ripple ⁵⁾	± 10 %													
Current consumption ⁶⁾	≤ 25 mA													
Switching outputs	PNP, open collector: Q NPN, open collector: Q													
Output current I_A max.	100 mA													
Light receiver, switching type	Light/dark switching per rotary switch													
Response time ^{7)/} Max. switching frequ. ⁸⁾	≤ 0.5 ms / 1000/s													
Connection type: connection cable	PVC, 2 m ⁹⁾ ; 3 x 0.2 mm ² , ø 4.2 mm													
plug	3 pin, M8													
plug	4 pin, M8													
VDE protection class ¹⁰⁾	□													
Protection circuits ¹¹⁾	A, B, C, D													
Enclosure rating	IP 67													
Ambient temperature	Operation -25... +55 °C Storage -40 ... +70 °C													
Weight	With connection cable approx. 60 g With plug approx. 20 g													
Housing material	Housing: PBT; optics: PMMA													

- 1) Scanned material with 90 % reflectance (with reference to standard white according to DIN 5033)
- 2) Object size 30 x 30 mm
- 3) Average service life 100,000 h at $T_U = +25 °C$
- 4) Limit values
- 5) May not exceed or fall short of V_S tolerances
- 6) Without load
- 7) Signal operating time with ohmic load
- 8) With light/dark ratio 1:1
- 9) Do not bend connection cable below 0 °C
- 10) Rated voltage DC 50 V
- 11) A = V_S connections reverse-polarity protected
B = Inputs and outputs reverse-polarity protected
C = Interference pulse suppression
D = Outputs overload and short-circuit protected

Scanning distance

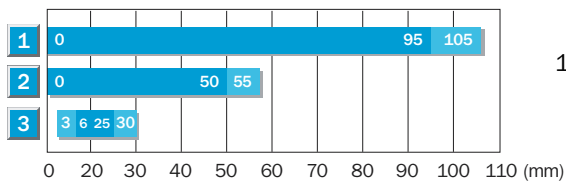

■ Operating scanning distance
■ Typ. max. scanning distance

- 1 Scanning range on white, 90 % reflectance
- 2 Scanning range on gray, 18 % reflectance
- 3 Scanning range on black, 6 % reflectance

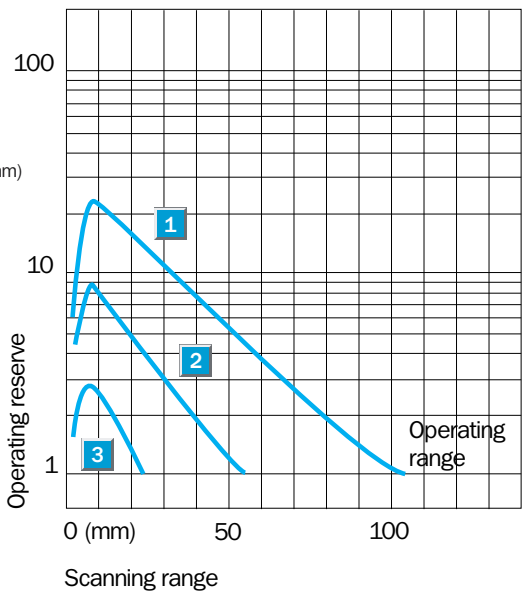

Ordering information

Type	Order no.
WT 160-F152	6 022 799
WT 160-F350	6 022 803
WT 160-F450	6 022 804
WT 160-F162	6 022 801
WT 160-F360	6 022 805
WT 160-F460	6 022 806
WT 160-E152	6 022 791
WT 160-E350	6 022 795
WT 160-E450	6 022 796
WT 160-E162	6 022 793
WT 160-E360	6 022 797
WT 160-E460	6 022 798

Scanning range
0.01 ... 6 m

Photoelectric reflex switch

- Horizontal and vertical models
- Polarizing filter for detecting objects with reflecting surfaces
- Contamination control with green LED indicator and contamination control output

Dimensional drawing

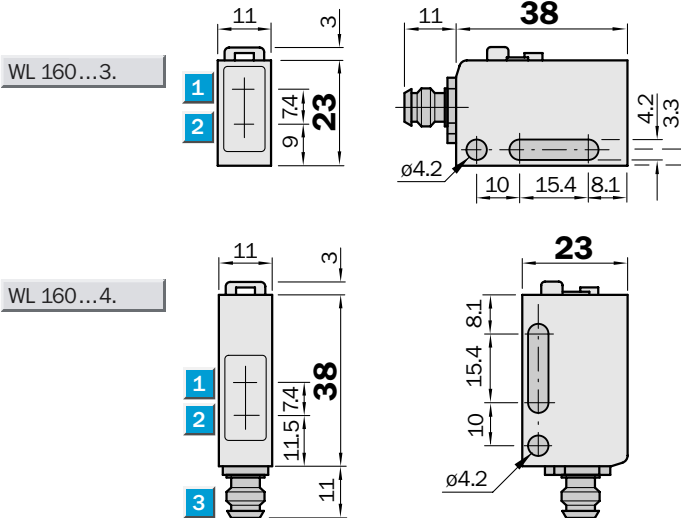

Setting options

All types

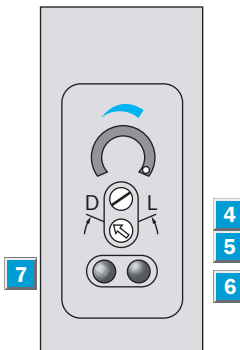

- 1 Optics center, receiver
- 2 Optics center, transmitter
- 3 Plug M 8 or connection cable
- 4 Sensitivity control
- 5 Light/dark rotary switch:
L = light switching
D = dark switching
- 6 Orange LED indicator (Status output)
- 7 Green LED signal strength indicator (Operating reserve)



Connection type

WL 160-E132	WL 160-E330	WL 160-E430
WL 160-E142	WL 160-E340	WL 160-E440
WL 160-F132	WL 160-F330	WL 160-F430
WL 160-F142	WL 160-F340	WL 160-F440

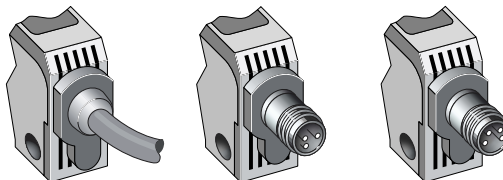

3x0.2 mm²

3 pin, M 8

4 pin, M 8

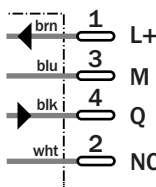
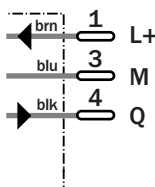
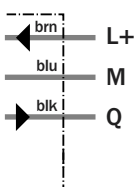

Accessories

Cable receptacles

Mounting bracket (included)

Reflectors (P250 included)

NC = not connected

Specifications		WL 160-	F132	F330	F430	E132	E330	E430	F142	F340	F440	E142	E340	E440
Housing shape	Horizontal													
	Vertical													
Scanning range typ. max./on reflector	0.01 ... 6 m/PL 80 A													
	typ. max./on reflector 0.01... 4 m/P 250 (supplied w. equip.)													
Operating range	0.01 ... 3 m/P 250													
Adjustable sensitivity	Potentiometer, 2 rotations w. scaling 270°													
Light source ⁴⁾ , light type	LED, red light with polarizing filter													
Light spot diameter	Approx. 300 mm at 3 m distance													
Transmitter dispersion angle	Approx. 4.5°													
Supply voltage V_S	DC 10 ... 30 V ²⁾													
Residual ripple ³⁾	± 10 %													
Current consumption ⁴⁾	≤ 25 mA													
Switching outputs	PNP, open collector: Q													
	NPN, open collector: Q													
Output current I_A max.	100 mA													
Light receiver, switching type	Light/dark switching per rotary switch													
Response time ⁵⁾ / Max. switching frequ. ⁶⁾	≤ 0.5 ms /1000/s													
Connection type: connection cable	PVC, 2 m ⁷⁾ ; 3 x 0.2 mm ² , ø 4.2 mm													
	plug 3 pin, M8													
	plug 4 pin, M8													
VDE protection class ⁸⁾	□													
Protection circuits ⁹⁾	A, B, C, D													
Enclosure rating	IP 67													
Ambient temperature	Operation -25 ... +55 °C													
	Storage -40 ... +70 °C													
Weight	With connection cable approx. 60 g													
	With plug approx. 20 g													
Housing material	Housing: PBT; optics: PMMA													

- 1) Average service life 100,000 h at $T_U = +25\text{ °C}$
- 2) Limit values
- 3) May not exceed or fall short of V_S tolerances
- 4) Without load
- 5) Signal operating time with ohmic load
- 6) With light/dark ratio 1:1
- 7) Do not bend connection cable below 0 °C
- 8) Rated voltage DC 50 V
- 9) A = V_S connections reverse-polarity protected
B = Inputs and outputs reverse-polarity protected
C = Interference pulse suppression
D = Outputs overload and short-circuit protected

Scanning range and operating reserve

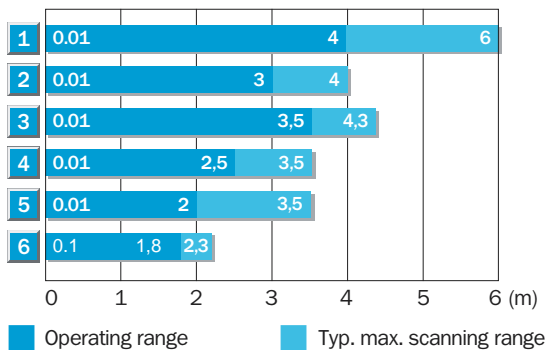

Reflector type	Operating Range
1 PL80 A	0.01 ... 4 m
2 PL250	0.01 ... 3 m
3 PL50 A/PL40 A	0.01 ... 3.5 m
4 PL30 A/PL31A	0.01 ... 2.5 m
5 PL20 A	0.01 ... 2 m
6 Reflective tape Diamond Grade	0.1 ... 1.8 m (100x100 mm ²)

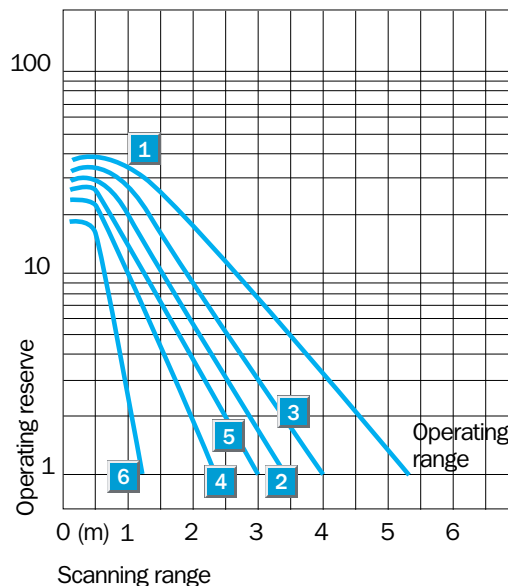

Ordering information

Type	Order no.
WL 160-F132	6 022 767
WL 160-F330	6 022 771
WL 160-F430	6 022 772
WL 160-F142	6 022 769
WL 160-F340	6 022 773
WL 160-F440	6 022 774
WL 160-E132	6 022 759
WL 160-E330	6 022 763
WL 160-E430	6 022 764
WL 160-E142	6 022 761
WL 160-E340	6 022 765
WL 160-E440	6 022 766

Scanning range
14 m

Through-beam photoelectric switch

- Horizontal and vertical models
- Slotted masks for increasing switching frequency
- Contamination control with green LED indicator and contamination control output



Dimensional drawing

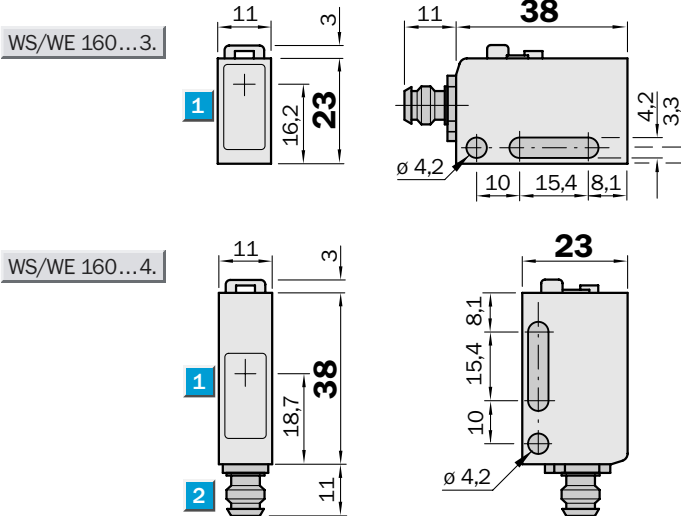

Setting options

All types

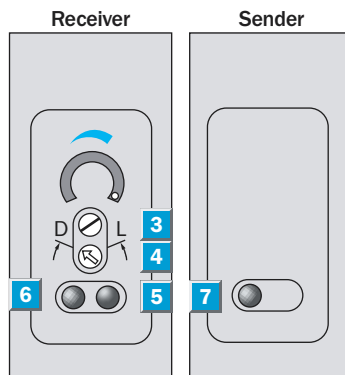

- 1** Optics center
- 2** Plug, M 8 or connection cable
- 3** Sensitivity control
- 4** Light/dark rotary switch:
L = light switching
D = dark switching
- 5** Orange LED indicator (Status output)
- 6** Green LED signal strength indicator (Operating reserve)
- 7** Indicator red (sender active)



Connection type

WS/WE 160-E132	WS/WE 160-E330	WS/WE 160-E430
WS/WE 160-E142	WS/WE 160-E340	WS/WE 160-E440
WS/WE 160-F132	WS/WE 160-F330	WS/WE 160-F430
WS/WE 160-F142	WS/WE 160-F340	WS/WE 160-F440

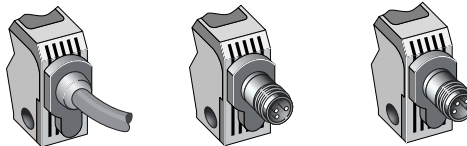

2x0.2 mm² 3 pin, M8 4 pin, M8

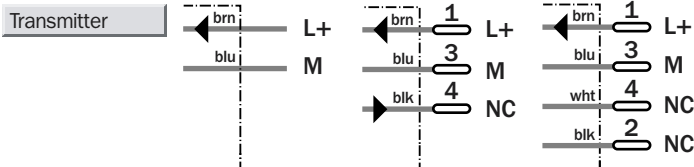

3x0.2 mm² 3 pin, M8 4 pin, M8

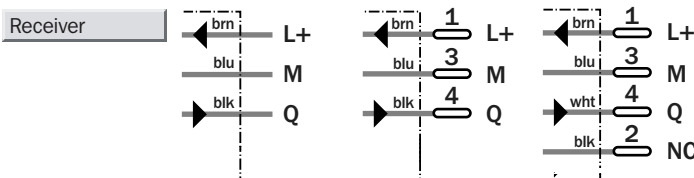

Accessories

- Cable receptacles
- Mounting bracket (included)
- Slotted mask

Specifications		WS/WE 160-	F132	F330	F430	E132	E330	E430	F142	F340	F440	E142	E340	E440	
Housing shape	Horizontal														
	Vertical														
Scanning range typ. max.	0 ... 14 m														
Operating range	0 ... 10 m														
Operating range with filter,	0 ... 2 m														
Width	1.0 mm														
Adjustable sensitivity	Potentiometer, 2 rotations w. scaling 270°														
Light source ⁴⁾ , light type	LED, red light														
Light spot diameter	Approx. 1500 mm at 10 m distance														
Transmitter dispersion angle	Approx. 3.3°														
Receiver angle	Approx. 15°														
Supply voltage V_S	DC 10 ... 30 V ²⁾														
Residual ripple ³⁾	± 10 %														
Current consumption ⁴⁾ transmitter	≤ 20 mA														
receiver	≤ 20 mA														
Switching outputs	PNP, open collector: Q														
	NPN, open collector: Q														
Output current I_A max.	100 mA														
Light receiver, switching type	Light/dark switching per rotary switch														
Response time ⁵⁾ / Max. switching frequ. ⁶⁾	≤ 0.5 ms / 1000/s														
Connection type: connection cable	PVC, 2 m ⁷⁾														
transmitter WS	2 x 0.2 mm ² , ø 4.2 mm														
receiver WE	3 x 0.2 mm ² , ø 4.2 mm														
plug	3 pin, M8														
plug	4 pin, M8														
VDE protection class ⁸⁾	□														
Protection circuits ⁹⁾ transmitter WS	A, B														
receiver WS	A, B, C, D														
Enclosure rating	IP 67														
Ambient temperature	Operation -25 ... +55 °C														
	Storage -40 ... +70 °C														
Weight with connection cable	transmitter/receiver each approx. 60 g														
with plug	transmitter/receiver each approx. 20 g														
Housing material	Housing: PBT; optics: PMMA														

- | | | | |
|--|--|---|--|
| 1) Average service life 100,000 h at $T_U = +25\text{ °C}$ | 5) Signal operating time with ohmic load | 8) Rated voltage DC 50 V | D = Outputs overload and short-circuit protected |
| 2) Limit values | 6) With light/dark ratio 1:1 | 9) A = V_S connections reverse-polarity protected | 10) Order no. includes transmitter and receiver |
| 3) May not exceed or fall short of V_S tolerances | 7) Do not bend connection cable below 0 °C | B = Inputs and outputs reverse-polarity protected | |
| 4) Without load | | C = Interference pulse suppression | |

Scanning range and operating reserve

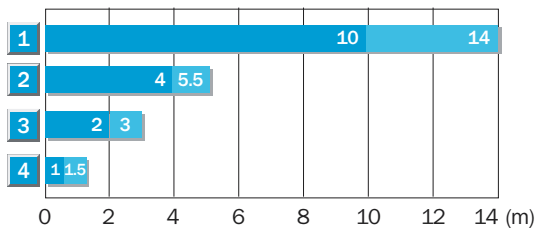

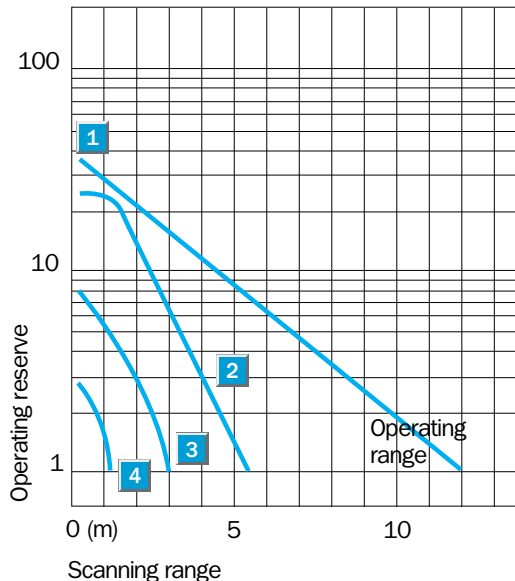

■ Operating range
■ Typ. max. scanning range

- | | |
|---|-------------------------------------|
| 1 | Without slotted mask |
| 2 | With slotted mask 2 mm, BL-160-SK |
| 3 | With slotted mask 1 mm, BL-160-SK |
| 4 | With slotted mask 0.5 mm, BL-160-SK |



Ordering information

Type	Order no. ¹⁰⁾
WS/WE 160-F132	6 022 751
WS/WE 160-F330	6 022 755
WS/WE 160-F430	6 022 756
WS/WE 160-F142	6 022 753
WS/WE 160-F340	6 022 757
WS/WE 160-F440	6 022 758
WS/WE 160-E132	6 022 743
WS/WE 160-E330	6 022 747
WS/WE 160-E430	6 022 748
WS/WE 160-E142	6 022 745
WS/WE 160-E340	6 022 749
WS/WE 160-E440	6 022 750

	Scanning range max. 2 m
Through-beam system	
	Scanning distance max. 70 mm
Scanner system	

- Sensitivity setting with potentiometer, scaled
- Large selection of LL3 fiber-optic cables (accessories)
- Switch-off delay 0 to 100 ms
- Contamination control output and test input for equipment and system testing

Dimensional drawing

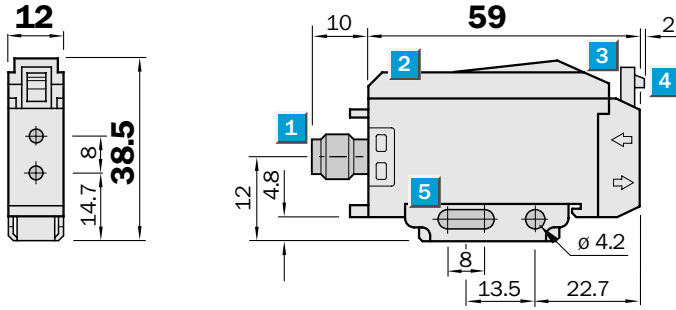

Setting options

All types

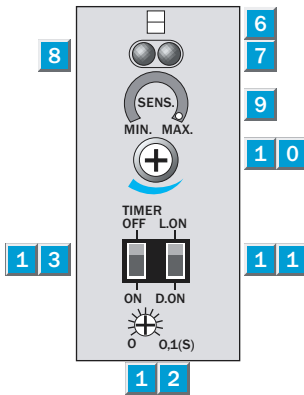

- 1** Plug 4 pin, M8 or connection cable
- 2** Protective hood
- 3** Locking the fiber-optic cables (press down)
- 4** Releasing the fiber-optic cables (press lug)
- 5** Mounting bracket, supplied with equipment
- 6** Indication of correct fiber-optic cable mounting
- 7** Red LED signal strength indicator (lights when switching threshold is exceeded)
- 8** Green LED signal strength indicator (lights when operating reserve is exceeded > 1.3)
- 9** Sensitivity scale
- 1 0** Sensitivity switch (4 turns)
- 1 1** Light/dark switching
- 1 2** Switch-off delay 0 ... 100 ms
- 1 3** Time delay on/off switch

Connection type

WLL 160-F 122	WLL 160-F 420
WLL 160-E 122	WLL 160-E 420

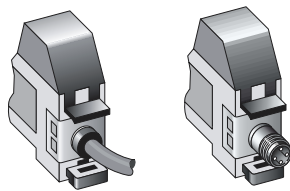

5 x 0.18 mm²

4 pin, M8

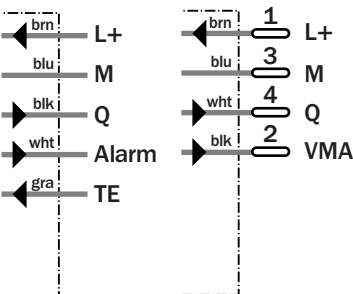

Accessories

- Cable receptacles
- LL3 fiber-optic cables



Specifications		WLL 160-	F122	F420	E122	E420					
Suitable fiber-optic cables	LL3 plastic fiber-optic cable series										
Scanning distances	Dependent on used fiber-optic cable type										
Oper. range, through-beam system	0 ... 500 mm (with tip adapter 0 ... 2 m)										
Oper. scanning distance, scanner system	0 ... 70 mm ¹⁾										
Adjustable sensitivity	Potentiometer, 4 rotations w. scaling 270°										
Light source²⁾, light type											
Light reception with operating reserve	LED, visible red light ("Spot-Control")										
Light reception without operating reserve	LED, visible red-orange light ("Spot-Control")										
Light spot diameter	Dependent on the scanning range										
Opening angle of fiber-optic cables	Approx. 65°										
Supply voltage V_S											
Residual ripple ⁴⁾	DC 10 ... 30 V ³⁾										
Current consumption ⁵⁾	± 10 %										
	≤ 30 mA										
Switching outputs											
	PNP, open collector: Q										
	NPN, open collector: Q										
Output current I _A max.	100 mA										
Light receiver, switching type	Light/dark switching p.slide switch										
Response time ⁶⁾ / Max. switching frequ. ⁷⁾	≤ 0.35 ms / 1500/s										
VMA contamination message	100 mA, static										
Test input TE⁸⁾											
	Transmitter off; PNP: TE after +V										
	Transmitter off; NPN: TE after 0V										
Time delay T_{OFF} (switch-off delay)	Selectable, per slide switch										
Time range	Adjust., 0 ... 100 ms; potentiometer 270°										
Connection type: connection cable	PVC, 2m ⁹⁾ ; 5 x 0.2 mm ² , ø 4.2 mm										
plug	4 pin, M8										
VDE protection class¹⁰⁾	□										
Protection circuits ¹¹⁾	A, B, C, D										
Enclosure rating	IP 66										
Ambient temperature											
	Operation -25 ... +55 °C										
	Storage -40 ... +70 °C										
Weight											
	With connection cable approx. 80 g										
	With plug approx. 30 g										
Housing material											
	Housing: ABS										



- 1) Scanned material with 90 % reflectance (with reference to standard white according to DIN 5033)
 2) Average service life 100,000 h at T_U = + 25 °C
 3) Limit values

- 4) May not exceed or fall short of V_S tolerances
 5) Without load
 6) Signal operating time with ohmic load
 7) With light/dark ratio 1:1
 8) TE not with plug model

- 9) Do not bend connection cable below 0 °C
 10) Rated voltage DC 50 V
 11) A = V_S connections reverse-polarity protected

- B = Inputs and outputs reverse-polarity protected
 C = Interference pulse suppression
 D = Outputs overload and short-circuit protected

Ordering information	
Type	Order no.
WLL 160-F122	6 009 989
WLL 160-E122	6 009 981
WLL 160-F420	6 009 990
WLL 160-E420	6 009 982

	Scanning range max. 2 m
Through-beam system	
	Scanning distance max. 70 mm
Scanner system	

- Automatic setting of the switching threshold and hysteresis with Teach-In per push button or via external control wire ET
- Large selection of LL 3 plastic fiber-optic cables (accessories)
- Switching frequency 830/s or 1660/s, switchable

Dimensional drawing

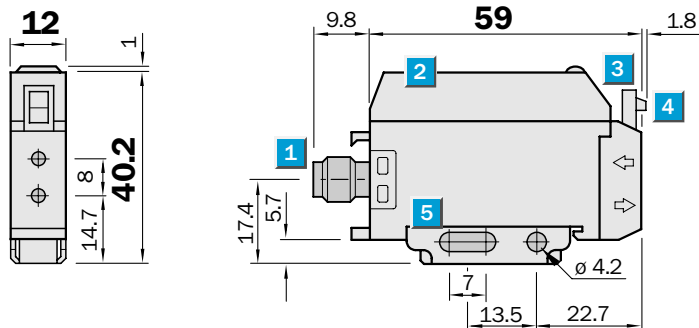

Setting options

All types

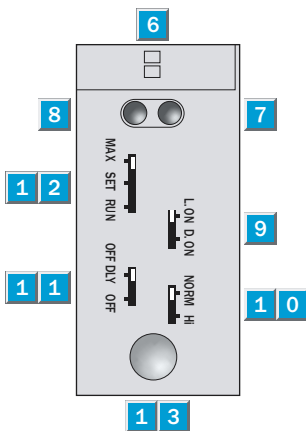

- 1** Plug 4 pin, M8 or connection cable
- 2** Protective hood
- 3** Lock the fiber-optic cables (press down)
- 4** Release the fiber-optic cables (press lug)
- 5** Mounting bracket, supplied with equipment
- 6** Indication of correct fiber-optic cable mounting
- 7** LED signal strength indicator, red (lights when switching threshold is exceeded)
- 8** LED signal strength indicator, green
- 9** Selector switch light ("L.ON")/dark switching ("D.ON")
- 10** Selector switch response time, NORM (600 μs)/HI (300 μs)
- 11** Selector switch switch-off delay On ("OFF DLY")/off ("OFF"); 40 ms fix
- 12** Operating mode selector switch "MAX/SET/RUN"
- 13** Push button Teach-In

Connection type

WLL 160T-F132	WLL 160T-F430
WLL 160T-E132	WLL 160T-E430

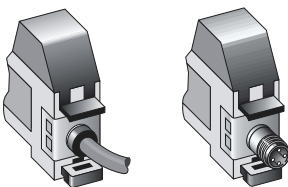

5 x 0.18 mm ²	4 pin, M8
--------------------------	-----------

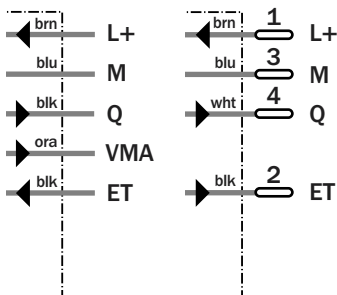

Accessories
Cable receptacles
LL3 fiber-optic cables

Specifications		WLL 160T-	F132	F430	E132	E430					
Suitable fiber-optic cables	LL 3 plastic fiber-optic cables										
Scanning distances	Dependent on used fiber-optic cable type										
Oper. range, through-beam system	0 ... 500 mm (with adapter tips 0 ... 2 m)										
Oper. scanning distance, scanner system	0 ... 70 mm ¹⁾										
Adjustable sensitivity	Automatic, per TEACH-IN key or "MAX" mode										
Mode selector switch "MAX" position	Max. range, set permanently										
"SET" position	TEACH-IN key activated										
"RUN" position	TEACH-IN key inactive										
TEACH-IN	Equipment in sensor mode										
manual	Per push button (only active if mode switch is in "SET" position)										
Extern TEACH-IN	Only active, if mode switch is in "RUN" position										
	PNP: control wire + V										
	NPN: control wire 0 V										
Light source²⁾, light type	LED, visible red light										
Light spot diameter	Dependent on the range										
Opening angle of fiber-optic cables	Approx. 65°										
Supply voltage V_S	DC 10 ... 24 V										
Residual ripple ³⁾	≤ 5 V _{SS}										
Current consumption ⁴⁾	≤ 50 mA										
Switching outputs	PNP, open collector: Q										
	NPN, open collector: Q										
Output current I _A max.	100 mA										
Light receiver, switching type	Light/dark switching per slide switch										
Response time ⁵⁾ /Max. switching freq. ⁶⁾	Dependent on selected operating mode! "Mode"-Selector switch in Pos. "MAX" or Selector switch "Response time" in "NORM" position: ≤ 0.6 ms/830/s, selectable Selector switch "Resp. time" in Pos. "HI": ≤ 0.3 ms/1660/s ⁷⁾										
VMA contamination message	30 mA, one shot, pulse length 40 ms										
Time delay T_{OFF} (switch-off delay)	40 ms fixed, selectable, per slide switch										
Connection type: connection cable	PVC, 2m ⁸⁾ ; 5 x 0.18 mm ² , ø 4.0 mm										
plug	4 pin, M8										
VDE protection class⁹⁾	□										
Protection circuits ¹⁰⁾	A, B, C, D										
Enclosure rating	IP 66										
Ambient temperature	Operation - 25 ... + 55 °C Storage - 40 ... + 70 °C										
Weight	With connection cable approx. 80 g With plug approx. 30 g										
Housing material	Housing: ABS										

- 1) Scanned material with 90% reflectance (with reference to standard white according to DIN 5033)
2) Average service life 100.000 h at T_U = + 25 °C

- 3) May not exceed or fall short of V_S tolerances
4) Without load
5) Signal operating period with ohmic load
6) With light/dark ratio 1:1

- 7) Scanning distance reduction approx. 30 %
8) Do not bend connection cable below 0° C
9) Withstand voltage DC 50 V
10) A = V_S connections reverse-polarity protected

- B = Inputs and outputs reverse-polarity protected
C = Interference pulse suppression
D = Outputs overload and short-circuit protected

Ordering Information	
Type	Order no.
WLL 160T-F132	6 010 650
WLL 160T-F430	6 010 651
WLL 160T-E132	6 010 648
WLL 160T-E430	6 010 649

1. Precise sensitivity setting (per 2x push of button); WLL 160T

TEACH-IN steps

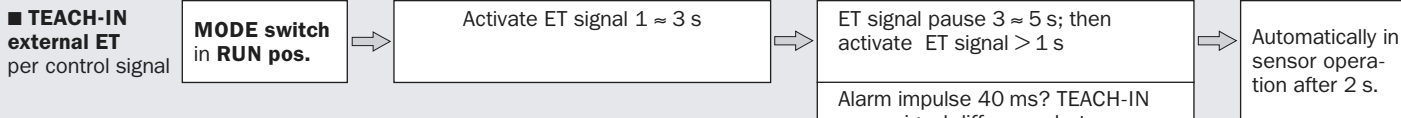
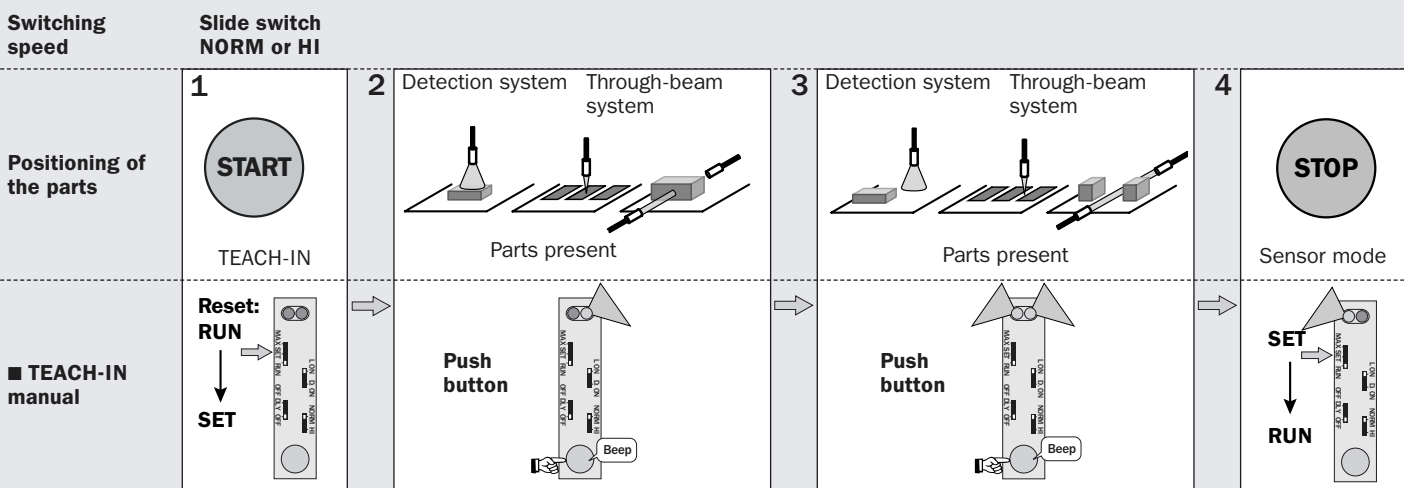

The TEACH-IN button is pressed twice. This operating mode provides **high sensitivity** and is ideal for **very precise switching points**. The WLL 160T optimizes the switching threshold and hysteresis per μ -processor automatically and stores them in EEPROM. No special experience in precise alignment of optoelectronic components necessary.

Applications:
Through-beam system; even thin or transparent objects are detected.
Detection system; strong background interference, small or dark scanning objects, simple marks with contrast differences.

Alarm impulse 40 ms? TEACH-IN error, signal difference between part present/absent too small. Check application.

2. Simple sensitivity setting (per 1x push of button); WLL 160T

TEACH-IN steps

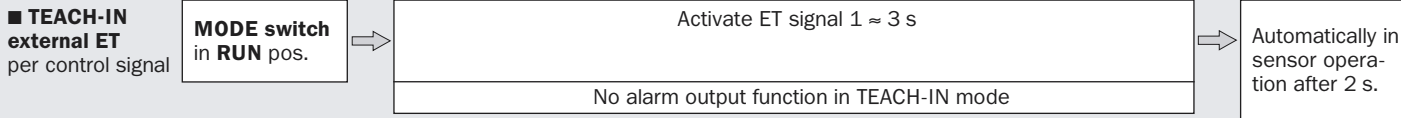
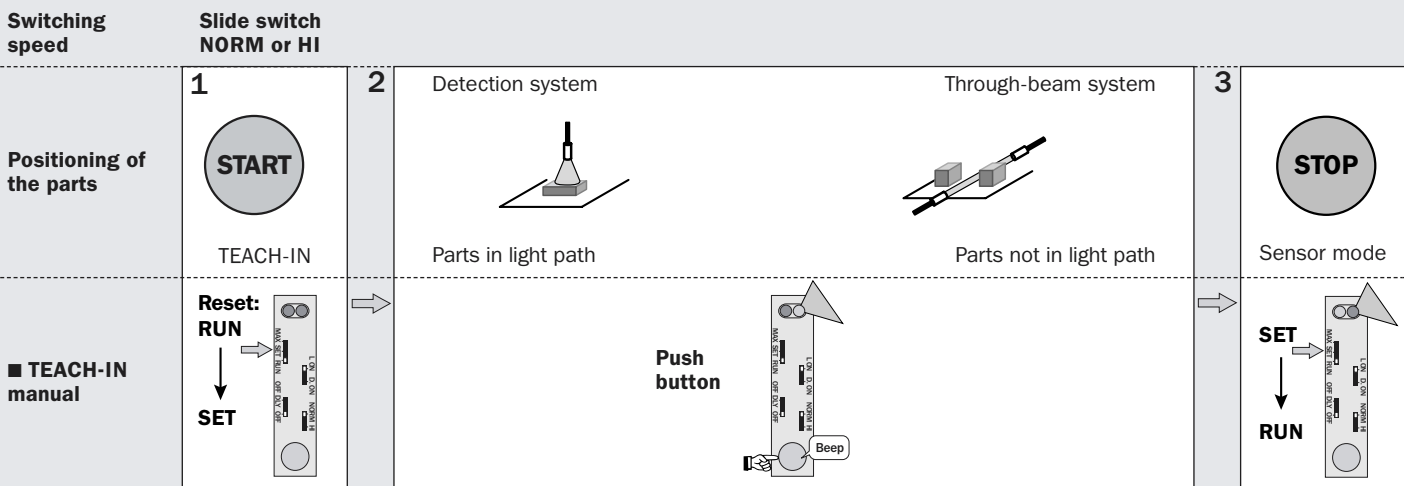

The TEACH-IN button is only pressed once. This operating mode provides **simple handling**. The WLL 160T system detects existing background interference automatically. The WLL20 160T optimizes the switching threshold and stores it in EEPROM. No special experience in setting the sensitivity of optoelectronic components necessary.

Applications:
Through-beam system; even small or partially transparent parts, which do not interrupt the light path completely, are detected. Detection system; background interference considered.

3. Max. scanning range, fixed setting; WLL 160T

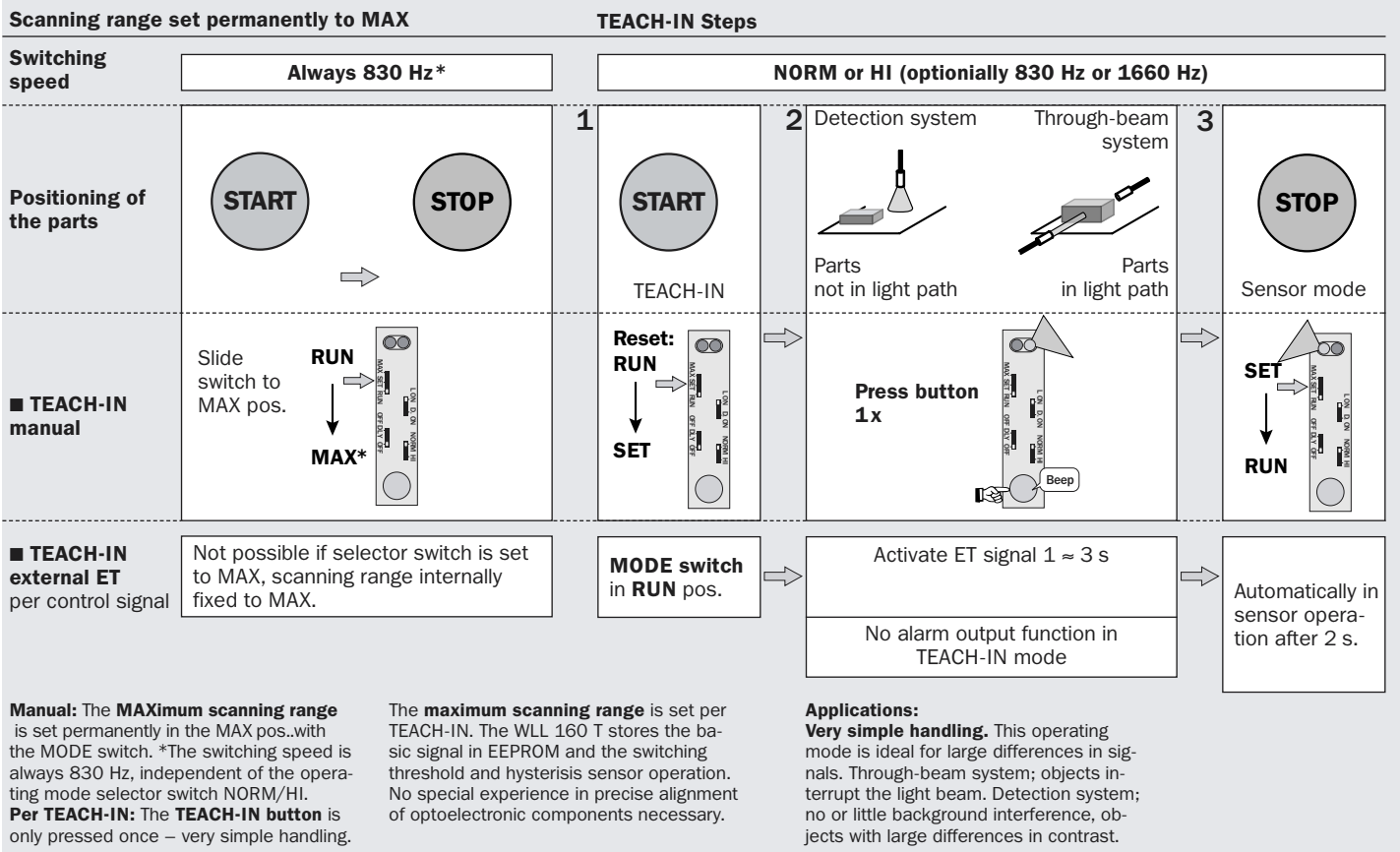

4. Moving objects; precise sensitivity adjustment (per 2x push of button); WLL 160T

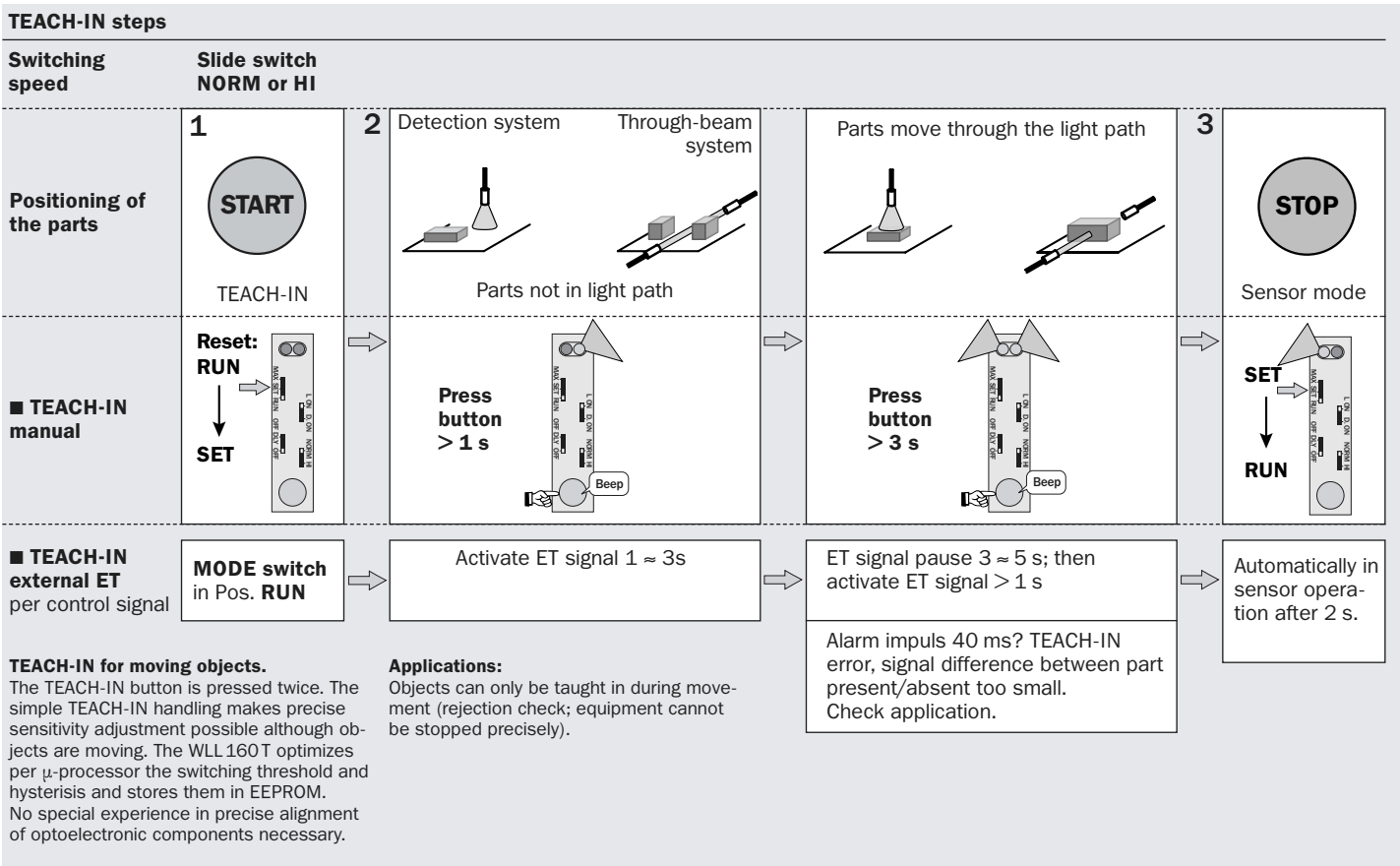

Functions WLL 160T TEACH-IN

Response time/switching speed

NORM: 830 Hz; max. system scanning distance.

HI: 1660 Hz, system scanning distance 70 %. Select before TEACH-IN!

Switch-off delay T_{OFF}

For switching output Q. Optional connection, 40 ms fixed. To ensure that your control can also detect shorter events.

Selector switch switching output Q

L.ON: light switching
D.ON: dark switching optionally in PNP or NPN.

Connection technique

Optionally M8 plug, 4 pin (no alarm output) or 5-wire connecting cable.

Alarm output

- **TEACH-IN mode:** signals TEACH-IN error.
- **Sensor mode (RUN):** signals insufficient signal reserve, e.g., due to soiling or misalignment (not with plug version M8 – 4 pin).

WLL 160T Assembly technology

Assembly and disassembly on tophat profile rail mounting by pulling the locking device.

Mounting technique

Simple snap-on on tophat profile rails. Mounting bracket supplied with equipment.

µ-Processor technique with EEPROM

Permanent storage of taught-in switching threshold and hysteresis, even when there are longer interruptions of voltage.

TEACH-IN button

Sensitivity setting at the push of a button. No special knowledge of phototelectric switches required. Only active if MODE selector switch is set to SET pos. (manipulation protection).

TEACH-IN mode selector switch

Separate from operating mode functions, and consequently simple and easy-to-understand handling; no double functions.

■ **MAX:** Maximum scanning range set permanently. Caution: switching speed independent of operating mode selection; switching speed always 830 Hz.

■ **SET:** WLL 160T in manual TEACH-IN mode. Optimum switching point setting at the simple push of a button (1 or 2 times).

■ **RUN:** optionally
– **TEACH-IN manual:** The taught-in switching threshold and hysteresis are stored in EEPROM. The WLL 160 T operates in sensor mode after 2 s.

– **External TEACH-IN (ET):** Optimum system adjustment using external control signal. Ideal if the WLL 160T is not accessible or part changes are often aligned automatically.

Fiber-optic cable lock

Press down bracket: fiber-optic cables are locked. Press the lug: fiber-optic cables are released.

Fiber-optic cable attachment

- Transmitter fiber-optic cable
 - Receiver fiber-optic cable
- Suitable fiber-optic cable: **plastic fiber-optic cables of the LL3 series** (see the description of the LL3 variants).

BUZZER

For acoustic support. Short tone after TEACH-IN = O.K.
Long tone after TEACH-IN = error or application not suitable.

LED display red, green

- **TEACH-IN mode:**
Signalization TEACH-IN process.
Permanently blinking: TEACH-IN error.
Permanently lit: TEACH-IN o.K.
- **Sensor operation:**
LED red: switching threshold exceeded
LED green: received signal > 1.1 or < 0.9

External TEACH-IN signal ET

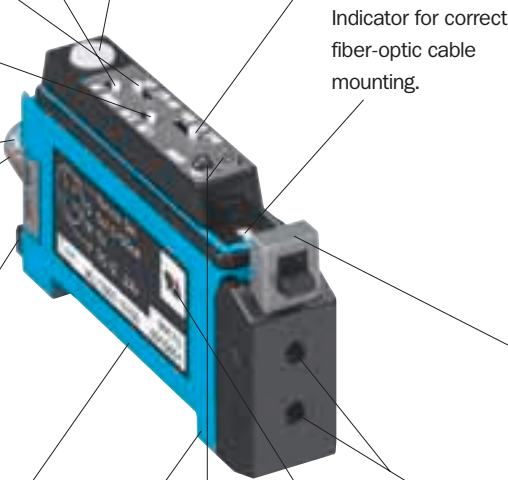
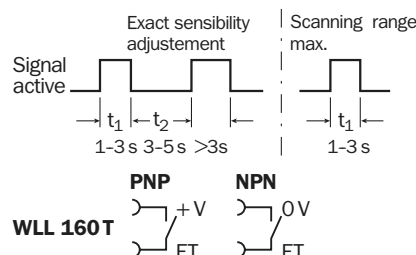

Indicator for correct fiber-optic cable mounting.



LL 3

Plastic Fiber-Optic Cables

– Flexible in Every Sense of the Word



Their great variety is another factor: a total of approximately 50 different models of the LL 3 provide optimum alternatives for almost all applications from optical, mechanical and chemical standpoints. Various tip adapters make additional applications possible. The LL 3 fiber-optic cables and the corresponding photoelectric fiber-optic switches from SICK create a strong team. They are especially useful in the semi-conductor, electronics assembly, packaging, handling and assembly systems, special mechanical engineering and precision engineering.

	Fiber-optic cable through-beam systems
	Fiber-optic cable scanner systems

No assembly space – not even for miniature photoelectric cables, chemical corrosion or increased ambient temperatures are often decisive reasons for the use of LL 3 plastic fiber-optic cables. In connection with the photoelectric switch series WLL 160(T), LL 3 cables enable reliable object detection even under difficult conditions.

Their multifaceted flexibility says a lot about the LL 3: small bending radii, simple shortening to the required length and different terminal sleeves make it possible to connect and lay them easily.

LL 3 options:

- Standard fiber-optic cables
- Large scanning ranges
- Tip adapters
- Small terminal sleeves
- Highly flexible with the smallest bending radii
- Integrated 90° offset
- Temperature resistant to 180 °C
- Teflon coating against aggressive environments
- Coaxial structure
- Pliable terminal sleeves
- 10 m length
- Fiber-optic lines
- Level switch ...

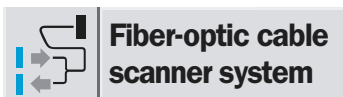

Characteristics



- Highly flexible
- Small bending radii
- Fiber-optic cables can be shortened easily with cutting device (supplied with equipment)
- Operation temperature $-40 \dots +70 \text{ }^\circ\text{C}$
Special models to $180 \text{ }^\circ\text{C}$

Selection table: sensors, fiber-optic cables, scanning distances				Scanning distances SD ¹⁾ and minimum object diameter MO ⁷⁾ in mm in connection with sensor type					
Scanner systems				WLL 160 Red light		WLL 160 T Red light (NORM/MAX)		WLL 160 T Red light (FAST)	
Description	Bending radius mm	Type	Order no.	SD		MO		MO	
				SD	MO	SD	MO	SD	MO
LL 3 Fiber-optic cables									
Compact sleeve, M 4, large scanning distance	25	LL 3-DM 01	5 308 071	70	0.015	70	0.015	50	0.015
Super compact sleeve, \varnothing 2.5 mm	15	LL 3-DT 03	5 308 072	20	0.015	20	0.015	14	0.015
Super compact, sleeve M 3	10	LL 3-DS 06	5 308 073	20	0.015	20	0.015	14	0.015
Large scanning distance, M 6, coaxial fiber-optic cable	25	LL 3-DB 01	5 308 074	70	0.02	70	0.015	50	0.015
Length 10 m, M 6, coaxial fiber-optic cable	25	LL 3-DB 01-1	5 308 075	40	0.015	40	0.015	30	0.015
For tip adapters, M 3	15	LL 3-DT 01	5 308 076	25	0.02	25/12 ²⁾	0.015	18	0.015
Thin, short sleeve, M 4, coaxial fiber-optic cable	25	LL 3-DM 02	5 308 077	25	0.02	25	0.015	18	0.015
Highly flexible, M 6, large scanning distance	4	LL 3-DR 01	5 308 078	70	0.02	70	0.015	50	0.015
Highly flexible, small sleeve, M 3	4	LL 3-DR 02	5 308 079	9	0.02	9	0.015	6	0.015
Highly flexible, \varnothing 3 mm, thin sleeve	4	LL 3-DR 03	5 308 080	20	0.02	20	0.015	14	0.015
Highly flexible, \varnothing 1.5 mm, thin sleeve	4	LL 3-DR 04 ⁴⁾	5 308 081	9	0.02	9	0.015	6	0.015
Highly flexible, M 4, compact sleeve	4	LL 3-DR 06	5 308 082	20	0.02	20	0.015	14	0.015
Flexible sleeve, M 6, large scanning distance	25/10 ³⁾	LL 3-DB 02	5 308 083	70	0.02	70	0.015	50	0.015
Flexible sleeve, M 4	25/10 ³⁾	LL 3-DM 03	5 308 084	20	0.02	20	0.015	14	0.015
Thin, long terminal tip, M 3	15	LL 3-DT 02	5 308 085	5	0.02	5	0.015	3	0.015
Thin, long terminal tip, M 3, coaxial fiber-optic cable	15	LL 3-DT 04 ⁴⁾	5 308 086	9	0.02	9	0.015	5	0.015
\varnothing 3.0 mm, thin terminal tip, \varnothing 0.82 mm	4	LL 3-DR 05 ⁴⁾	5 308 087	5	0.02	5	0.015	3	0.015
90° offset, \varnothing 5.0 mm	25	LL 3-DV 01	5 308 088	40	0.03	40	0.025	30	0.025
90° offset, small sleeve, \varnothing 3.0 mm	15	LL 3-DV 02	5 308 089	9	0.02	8	0.015	5	0.015
90° offset, M 6	25	LL 3-DV 03	5 308 090	40	0.03	40	0.025	30	0.025
Temp. resist. to $180 \text{ }^\circ\text{C}$, M 6, large scanning distance	30	LL 3-DH 01 ⁵⁾	5 308 091	100	0.02	100	0.015	70	0.015
Temperature resistant to $100 \text{ }^\circ\text{C}$, M 6	25	LL 3-DH 02 ⁶⁾	5 308 092	55	0.02	55	0.015	50	0.015
Teflon coating, chemically resistant, \varnothing 6.0 mm	40	LL 3-DY 01	5 308 093	●		45	0.02	●	
Level switch, clear liquid, \varnothing 6.0 mm	50	LL 3-DF 01	5 308 094	●		yes		●	
Level switch, cloudy liquid, \varnothing 6.0 mm	50	LL 3-DF 02	5 308 095	●		yes		●	

1) With reference to white scanned object, 90 % reflectance, minimum object diameter = light size (opening angle LL: approx. 65°) fiber-optic cable not shortened
 2) With scanner tip adapter für LL 3, see tip adapters for LL 3
 3) Bending radius of the flexible terminal sleeve
 4) Cannot be shortened
 5) Ambient operating temperature $-40 \dots +180 \text{ }^\circ\text{C}$
 6) Ambient operating temperature $-40 \dots +100 \text{ }^\circ\text{C}$
 7) Minimum object diameter: scanning distance reduction!

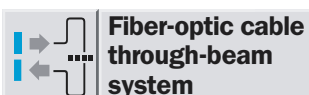

Fiber-optic cable through-beam system



Characteristics

- Highly flexible
- Small bending radii
- Fiber-optic cables can be shortened easily with cutting device (supplied with equipment)
- Ambient temperature $-40 \dots +70 \text{ }^\circ\text{C}$
Special models to $180 \text{ }^\circ\text{C}$

Selection table: sensors, fiber-optic cables, scanning ranges

Through-beam systems

LL 3 Fiber-optic cables

Scanning ranges SR¹⁾ and minimum object diameter MO⁶⁾ in mm in connection with sensor type

WLL 160 Red light		WLL 160 T Red light (NORM/MAX)		WLL 160 T Red light (FAST)	
SR	MO	SR	MO	SR	MO
200/2000 ²⁾	0,2/4,0	200/2000 ²⁾	0,2/4,0	150/1500 ²⁾	0,2/4,0
500	0,5	500	0,5	360	0,5
400/1500 ²⁾	0,5/4,0	400/1500 ²⁾	0,2/4,0	280/1500 ²⁾	0,2/4,0
250/900 ²⁾	0,5/4,0	250/900 ²⁾	0,5/4,0	190/660 ²⁾	0,5/4,0
180/1200 ²⁾	0,2/4,0	180/1200 ²⁾	0,2/4,0	130/850 ²⁾	0,2/4,0
50	0,2	50	0,1	40	0,2
50	0,2	50	0,1	40	0,2
50	0,2	50	0,1	40	0,2
200	0,2	200	0,2	150	0,2
18	0,1	18	0,1	10	0,2
150	0,2	150	0,2	130	0,2
40	0,2	40	0,2	30	0,2
40	0,2	40	0,2	30	0,2
200	0,2	200	0,2	150	0,2
700	0,5	700	0,5	400	0,5
260	1,0	260	1,0	190	1,0
180/1500 ²⁾	0,2/4,0	180/1500 ²⁾	0,2/4,0	130/1050 ²⁾	0,2/4,0
350	0,5	350	0,5	240	0,5
1000	0,8	1000	0,5	700	0,5
250	0,5	250	0,3	180	0,3
200	0,2	200	0,2	150	0,2
70	0,2	70	0,1	50	0,1
70	0,2	70	0,1	50	0,1

Description	Bending radius	Type	Order no.
	mm		
Standard, M 4	25	LL 3-TB 02	5 308 048
Standard, \varnothing 3 mm, large scanning range	35	LL 3-TS 07	5 308 049
Standard, M 4, large scanning range	25	LL 3-TB 01	5 308 050
Standard, M 4, length 10 m	25	LL 3-TB 01-10	5 308 051
Highly flexible, M 4, large scanning range	4	LL 3-TR 01	5 308 052
Highly flexible, M 3	4	LL 3-TR 02	5 308 053
Small sleeve, \varnothing 1,5 mm, highly flexible, length 1 m	4	LL 3-TR 03	5 308 054
Small sleeve, \varnothing 1,5 mm, highly flexible, length 2 m	4	LL 3-TR 03-2	5 308 055
Flexible terminal sleeve, M 4	25/10 ³⁾	LL 3-TB 03	5 308 056
Compact, M 3, terminal piece 1,0 m	15	LL 3-TT 01	5 308 057
90° offset, standard, \varnothing 3 mm	25	LL 3-TV 01	5 308 058
90° offset, compact, \varnothing 2,5 mm	15	LL 3-TV 02	5 308 059
90° offset, compact, M 3	15	LL 3-TV 04	5 308 060
90° offset, standard, \varnothing 3 mm	25	LL 3-TS 08	5 308 061
90° offset, large scanning range	25	LL 3-TS 12	5 308 062
Fiber-optic line	25	LL 3-TS 10	5 308 063
Temperature resistant, M 4	25	LL 3-TH 01 ⁴⁾	5 308 064
Temperature resistant to 180 °C, M 4	30	LL 3-TH 02 ⁵⁾	5 308 065
Teflon coating, \varnothing 6.0 mm, chemically resistant	40	LL 3-TY 01	5 308 066
Teflon coating, \varnothing 6.0 mm, chemically resistant	40	LL 3-TY 02	5 308 067
90° offset			
Small terminal sleeve, M 3, large scanning range	25	LL 3-TM 01	5 308 068
Small terminal sleeve, M 3	15	LL 3-TM 02	5 308 069
Small terminal sleeve, \varnothing 1,5 mm	15	LL 3-TM 03	5 308 070

- 1) Fiber-optic cable not shortened
- 2) With tip adapters for LL 3, also see tip adapters for LL 3
- 3) Bending radius of the flexible terminal sleeve
- 4) Ambient operating temperature $-40 \dots +100 \text{ }^\circ\text{C}$
- 5) Ambient operating temperature $-40 \dots +180 \text{ }^\circ\text{C}$
- 6) Minimum object diameter: scanning range reduction!

Flow diagrams of fiber-optic cable selection

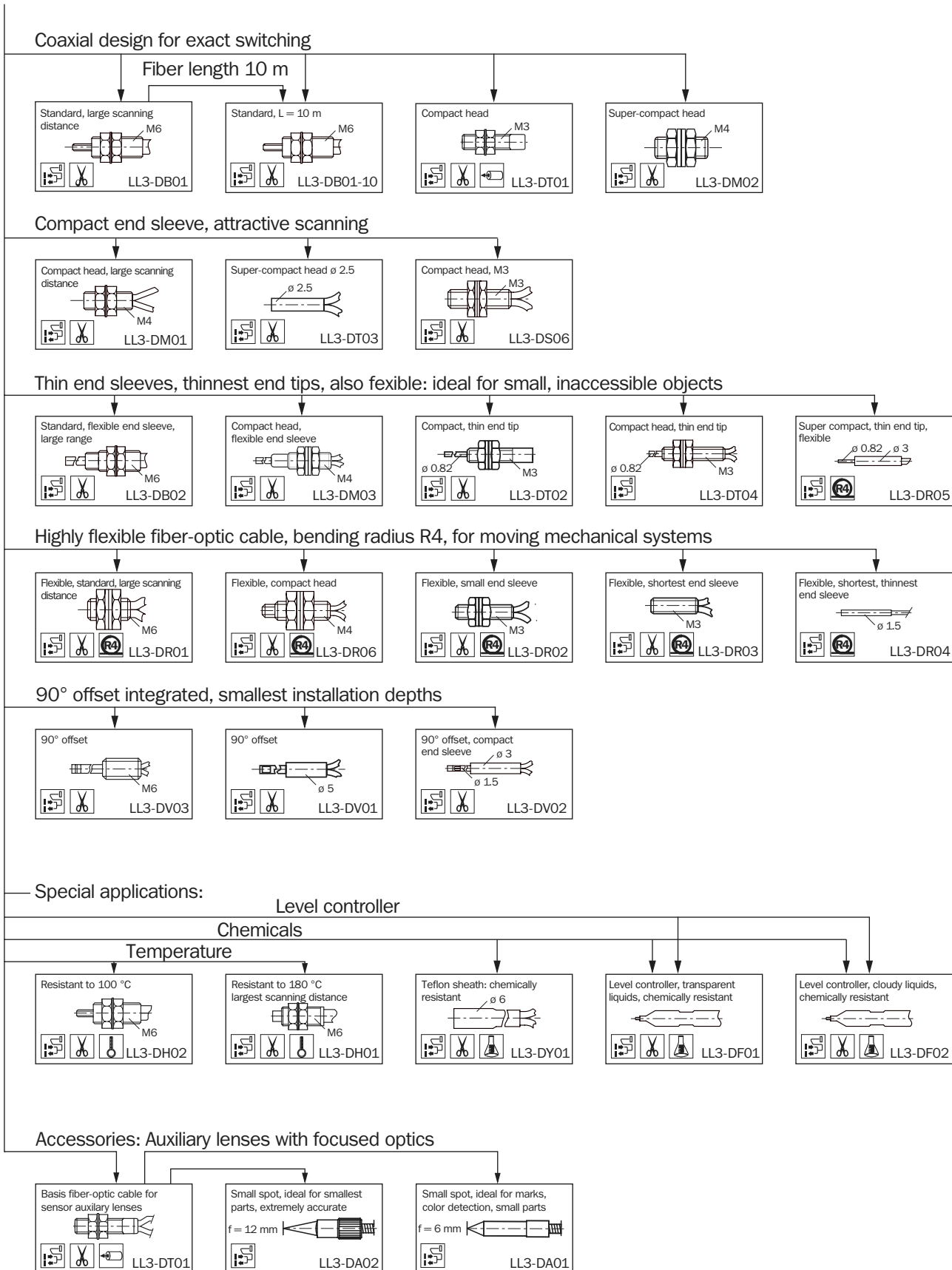
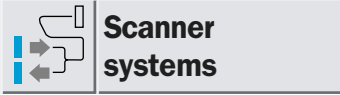

Flow diagrams of fiber-optic cable selection

Through-beam systems

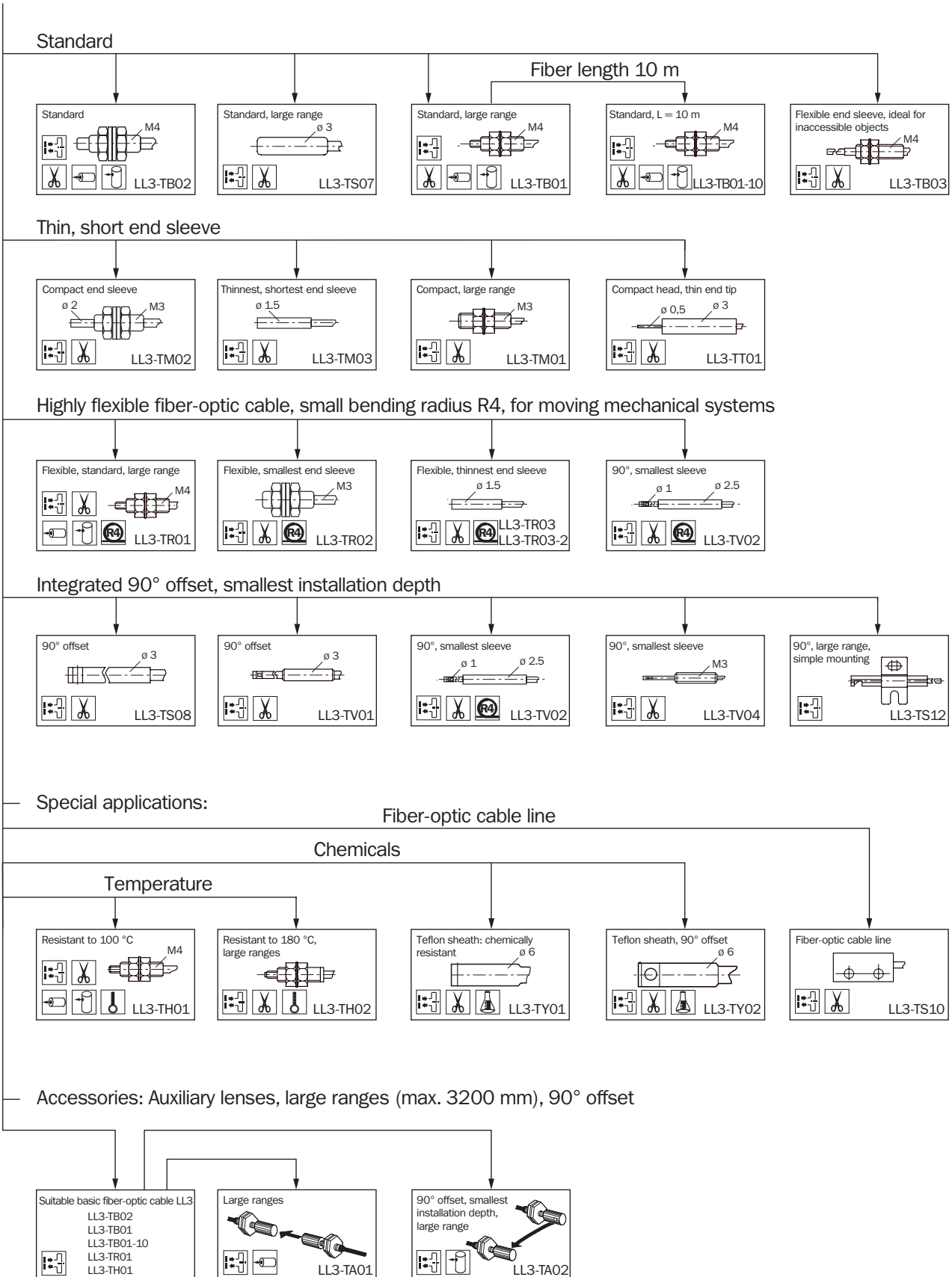

Tip adapters for through-beam systems

Large scanning ranges

- 1 Light spot \varnothing : approx. 170 mm at 1000 mm
- 2 Opening angle: approx. 15°
- 3 Material: CuZn (nickel-plated)/glass

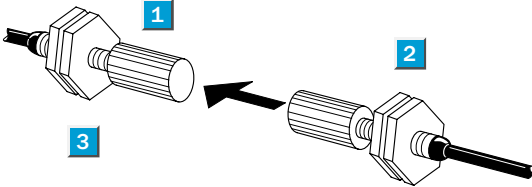

Ordering information

Type	Order no.
LL 3-TA01	5 308 128

Tip adapters for scanner systems

- For detecting the smallest parts
- Focussed, very small light spot \varnothing
- High sensitivity (6% reflectance)
- For suppressing background interference

- 1 Light spot \varnothing : approx. 0.25 mm in focus = 6 mm
- 2 Opening angle: focus = 6 mm
- 3 Material: Al (aluminum)/glass

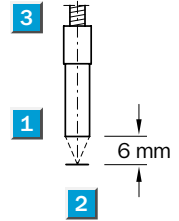

Ordering information

Type	Order no.
LL 3-DA01	5 308 127

Tip adapters for through-beam systems

Compact 90° offset

- 1 Light spot \varnothing : X axis: approx. 110 mm, Y axis: approx. 170 mm, each time when SR = 200 mm
- 2 Opening angle: X axis: approx. 30°, Y axis: approx. 40°
- 3 Material: CuZn (nickel-plated)/glass

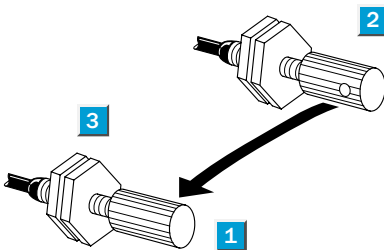

Ordering information

Type	Order no.
LL 3-TA02	5 308 129

Tip adapters for scanner systems

- Suitable as "mark" sensor for color marks
- Focussed, very small light spot \varnothing
- High sensitivity (6% reflectance)
- For suppressing background interference

- 1 Light spot \varnothing : approx. 3 mm in focus = 12 mm
- 2 Opening angle: focus = 12 mm
- 3 Material: Al (aluminum)/glass

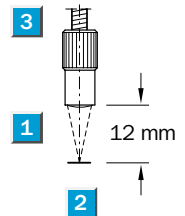

Ordering information

Type	Order no.
LL 3-DA02	5 308 130

Dimensional drawings for tip adapters for LL 3 fiber-optic cables

Ordering information	
Type	Order no.
LL 3-TA01	5 308 128

Ordering information	
Type	Order no.
LL 3-TA02	5 308 129

Ordering information	
Type	Order no.
LL 3-DA01	5 308 127

Ordering information	
Type	Order no.
LL 3-DA02	5 308 130

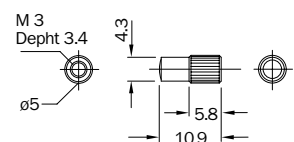
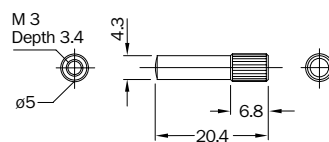
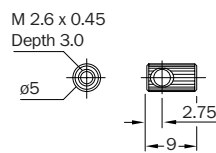
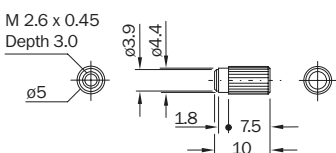

Dimensional drawings for LL 3 fiber-optic cables – scanner systems

Ordering information	
Type	Order no.
LL 3-DM01	5 308 071

Material: core: PMMA; coating: PE;
Sleeve: 1.4305 (German material no.)
Corrosion-resistant stainless steel

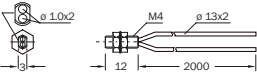

Ordering information	
Type	Order no.
LL 3-DT03	5 308 072

Material: core: PMMA; coating: PE;
Sleeve: 1.4305 (German material no.)
Corrosion-resistant stainless steel

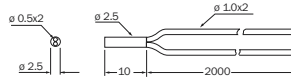

Ordering information	
Type	Order no.
LL 3-DS06	5 308 073

Material: core: PMMA; coating: PE;
Sleeve: 1.4305 (German material no.)
Corrosion-resistant stainless steel

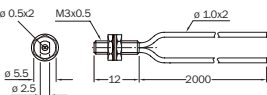

Ordering information	
Type	Order no.
LL 3-DB01	5 308 074

Material: core: PMMA; coating: PE;
Sleeve: 1.4305 (German material no.)
Corrosion-resistant stainless steel

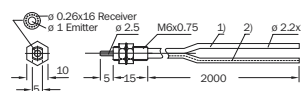

- 1) Transmitter
- 2) Receiver

Ordering information	
Type	Order no.
LL 3-DB01-10	5 308 075

Material: core: PMMA; coating: PE;
Sleeve: 1.4305 (German material no.)
Corrosion-resistant stainless steel

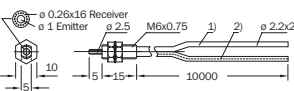

- 1) Transmitter
- 2) Receiver

Ordering information	
Type	Order no.
LL 3-DT01	5 308 076

Material: core: PMMA; coating: PE;
Sleeve: 1.4305 (German material no.)
Corrosion-resistant stainless steel

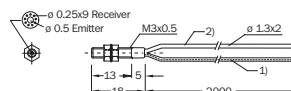

- 1) Transmitter
- 2) Receiver

Ordering information	
Type	Order no.
LL 3-DM02	5 308 077

Material: core: PMMA; coating: PE;
Sleeve: 1.4305 (German material no.)
Corrosion-resistant stainless steel

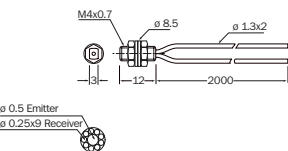

Ordering information	
Type	Order no.
LL 3-DR01	5 308 078

Material: core: PMMA; coating: PE;
Sleeve: 1.4305 (German material no.)
Corrosion-resistant stainless steel

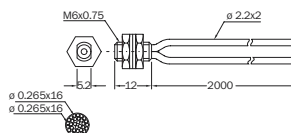

Ordering information	
Type	Order no.
LL 3-DR02	5 308 079

Material: core: PMMA; coating: PE;
Sleeve: 1.4305 (German material no.)
Corrosion-resistant stainless steel

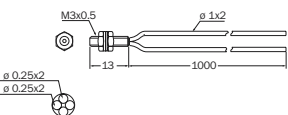

Ordering information	
Type	Order no.
LL 3-DR03	5 308 080

Material: core: PMMA; coating: PE;
Sleeve: 1.4305 (German material no.)
Corrosion-resistant stainless steel

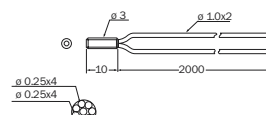

Ordering information	
Type	Order no.
LL 3-DR04	5 308 081

Material: core: PMMA; coating: PE;
Sleeve: 1.4305 (German material no.)
Corrosion-resistant stainless steel

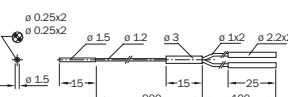

Ordering information	
Type	Order no.
LL 3-DR06	5 308 082

Material: core: PMMA; coating: PE;
Sleeve: 1.4305 (German material no.)
Corrosion-resistant stainless steel

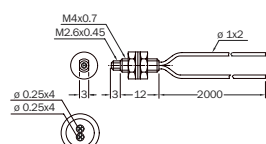

Dimensional drawings for LL 3 fiber optic cables – scanner systems

Ordering information

Type	Order no.
LL 3-DB02	5 308 083

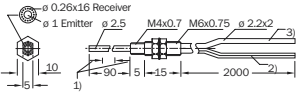

Material: core: PMMA; coating: PE;
Sleeve: 1.4305 (German material no.)
Corrosion-resistant stainless steel

- 1) Flexible terminal sleeve, do not bend in this area (10 mm), bending radius R 10
- 2) Transmitter (marked blue)
- 3) Receiver

Ordering information

Type	Order no.
LL 3-DM03	5 308 084

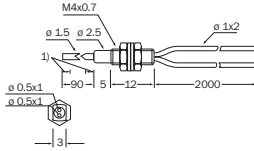

Material: core: PMMA; coating: PE;
Sleeve: 1.4305 (German material no.)
Corrosion-resistant stainless steel

- 1) Flexible terminal sleeve, do not bend in this area (10 mm), bending radius R 10

Ordering information

Type	Order no.
LL 3-DT02	5 308 085

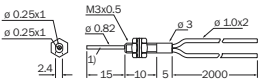

Material: core: PMMA; coating: PE;
Sleeve: 1.4305 (German material no.)
Corrosion-resistant stainless steel

- 1) Terminal sleeve inflexible

Ordering information

Type	Order no.
LL 3-DT04	5 308 086

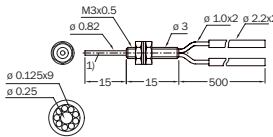

Material: core: PMMA; coating: PE; Sleeve:
CuZn brass nickel-plated

- 1) Terminal sleeve inflexible

Ordering information

Type	Order no.
LL 3-DR05	5 308 087

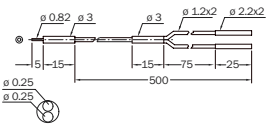

Material: core: PMMA; coating: PE; Sleeve:
CuZn brass nickel-plated

Ordering information

Type	Order no.
LL 3-DV01	5 308 088

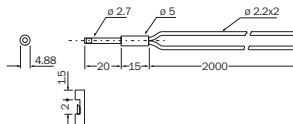

Material: core: PMMA; coating: PE;
Sleeve: 1.4305 (German material no.)
Corrosion-resistant stainless steel

Ordering information

Type	Order no.
LL 3-DV02	5 308 089

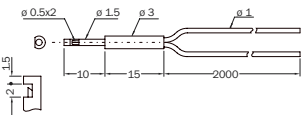

Material: core: PMMA; coating: PE;
Sleeve: 1.4305 (German material no.)
Corrosion-resistant stainless steel

Ordering information

Type	Order no.
LL 3-DV03	5 308 090

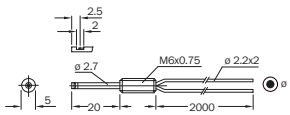

Material: core: PMMA; coating: PE;
Sleeve: 1.4305 (German material no.)
Corrosion-resistant stainless steel

Ordering information

Type	Order no.
LL 3-DH01	5 308 091

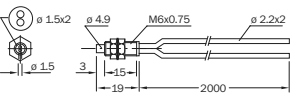

Material: core: PMMA; coating: PE;
Sleeve: 1.4305 (German material no.)
Corrosion-resistant stainless steel

Ordering information

Type	Order no.
LL 3-DH02	5 308 092

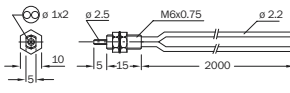

Material: core: PMMA; coating: PE;
Sleeve: 1.4305 (German material no.)
Corrosion-resistant stainless steel

Ordering information

Type	Order no.
LL 3-DY01	5 308 093

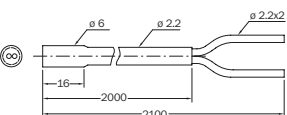

Material: core: PMMA; coating: Teflon;
Sleeve: Teflon

Ordering information

Type	Order no.
LL 3-DF01	5 308 094 ¹⁾
LL 3-DF02	5 308 095 ²⁾

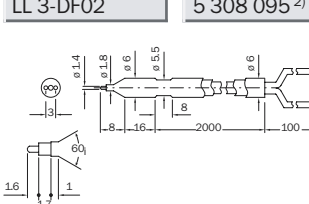

- 1) For transparent liquids
- 2) For cloudy liquids

Dimensional drawings for LL 3 fiber-optic cables – through-beam systems

Ordering information	
Type	Order no.
LL 3-TB02	5 308 048

Material: core: PMMA; coating: PE;
Sleeve: 1.4305 (German material no.)
Corrosion-resistant stainless steel

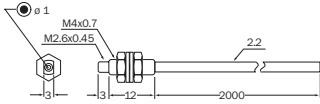

Ordering information	
Type	Order no.
LL 3-TS07	5 308 049

Material: core: PMMA; coating: PE;
Sleeve: 1.4305 (German material no.)
Corrosion-resistant stainless steel

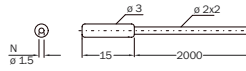

Ordering information	
Type	Order no.
LL 3-TB01	5 308 050

Material: core: PMMA; coating: PE;
Sleeve: 1.4305 (German material no.)
Corrosion-resistant stainless steel

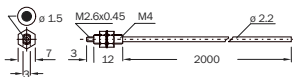

Ordering information	
Type	Order no.
LL 3-TB01-10	5 308 051

Material: core: PMMA; coating: PE;
Sleeve: 1.4305 (German material no.)
Corrosion-resistant stainless steel

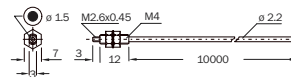

Ordering information	
Type	Order no.
LL 3-TR01	5 308 052

Material: core: PMMA; coating: PE;
Sleeve: CuZn brass nickel-plated

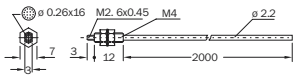

Ordering information	
Type	Order no.
LL 3-TR02	5 308 053

Material: core: PMMA; coating: PE;
Sleeve: 1.4305 (German material no.)
Corrosion-resistant stainless steel

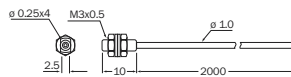

Ordering information	
Type	Order no.
LL 3-TR03	5 308 054

Material: core: PMMA; coating: PE;
Sleeve: 1.4305 (German material no.)
Corrosion-resistant stainless steel

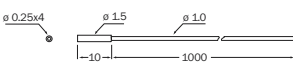

Ordering information	
Type	Order no.
LL 3-TR03-2	5 308 055

Material: core: PMMA; coating: PE;
Sleeve: 1.4305 (German material no.)
Corrosion-resistant stainless steel

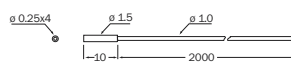

Ordering information	
Type	Order no.
LL 3-TB03	5 308 056

Material: core: PMMA; coating: PE;
Sleeve: 1.4305 (German material no.)
Corrosion-resistant stainless steel

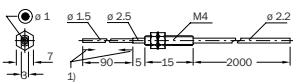

1) Flexible terminal sleeve, do not bend in this area (10 mm), bending radius R 10

Ordering information	
Type	Order no.
LL 3-TT01	5 308 057

Material: core: PMMA; coating: PE;
Sleeve: 1.4305 (German material no.)
Corrosion-resistant stainless steel

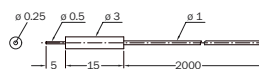

Ordering information	
Type	Order no.
LL 3-TV01	5 308 058

Material: core: PMMA; coating: PE;
Sleeve: 1.4305 (German material no.)
Corrosion-resistant stainless steel

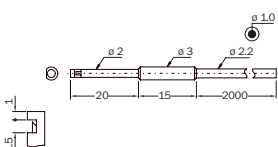

Ordering information	
Type	Order no.
LL 3-TV02	5 308 059

Material: core: PMMA; coating: PE;
Sleeve: 1.4305 (German material no.)
Corrosion-resistant stainless steel

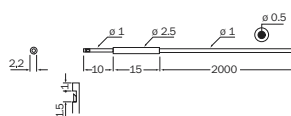

Dimensional drawings for LL 3 fiber-optic cables – through-beam systems

Ordering information

Type	Order no.
LL 3-TV04	5 308 060

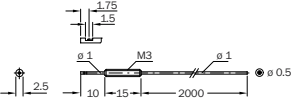

Material: core: PMMA; coating: PE;
Sleeve: 1.4305 (German material no.)
Corrosion-resistant stainless steel

Ordering information

Type	Order no.
LL 3-TS08	5 308 061

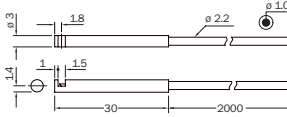

Material: core: PMMA; coating: PE;
Sleeve: 1.4305 (German material no.)
Corrosion-resistant stainless steel

Ordering information

Type	Order no.
LL 3-TS12	5 308 062

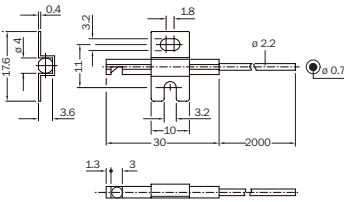

Material: core: PMMA; coating: PE;
Sleeve: 1.4305 (German material no.)
Corrosion-resistant stainless steel

Ordering information

Type	Order no.
LL 3-TS10	5 308 063

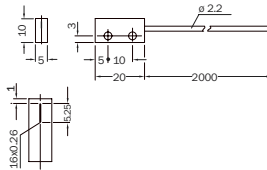

Material: core: PMMA; coating: PE; Sleeve:
CuZn brass nickel-plated

Ordering information

Type	Order no.
LL 3-TH01	5 308 064

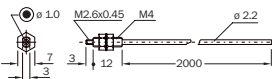

Material: core: PMMA; coating: PE; Sleeve:
CuZn brass nickel-plated

Ordering information

Type	Order no.
LL 3-TH02	5 308 065

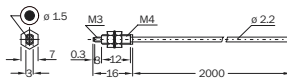

Material: core: HPOF; coating: FEP;
Sleeve: 1.4305 (German material no.)
Corrosion-resistant stainless steel

Ordering information

Type	Order no.
LL 3-TY01	5 308 066

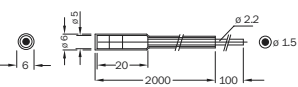

Material: core: PMMA; coating: Teflon;
Sleeve: Teflon

Ordering information

Type	Order no.
LL 3-TY02	5 308 067

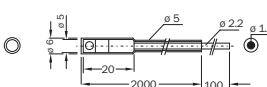

Material: core: PMMA; coating: Teflon;
Sleeve: Teflon

Ordering information

Type	Order no.
LL 3-TM01	5 308 068

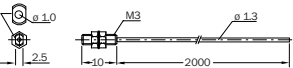

Material: core: PMMA; coating: PE;
Sleeve: 1.4305 (German material no.)
Corrosion-resistant stainless steel

Ordering information

Type	Order no.
LL 3-TM02	5 308 069

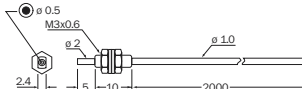

Material: core: PMMA; coating: PE;
Sleeve: 1.4305 (German material no.)
Corrosion-resistant stainless steel

Ordering information

Type	Order no.
LL 3-TM03	5 308 070

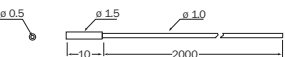

Material: core: PMMA; coating: PE; Sleeve:
1.4305 (German material no.) Corrosion-re-
sistant stainless steel

Dimensional drawings and ordering information

■ Pin assignment according to EN 50044

SENSICK circular screwing system M 8, 4 pin, enclosure rating IP 67

M 8 cable receptacle, 4 pin, straight

Type	Order no.
DOS-0804-G	6 009 974

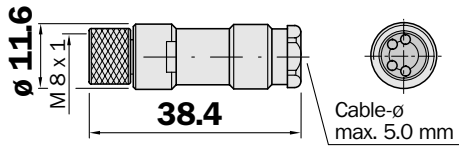

M 8 cable receptacle, 4 pin, angled

Type	Order no.
DOS-0804-W	6 009 975

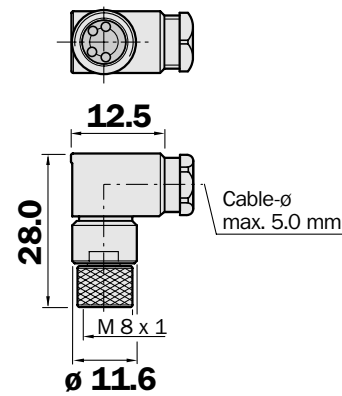

M 8 cable receptacle, 4 pin, straight

Cable ø 5 mm, 4 x 0.25 mm², PVC coating

Type	Order no.	Cable length
DOL-0804-G02M	6 009 870	2 m
DOL-0804-G05M	6 009 872	5 m
DOL-0804-G10M	6 010 754	10 m

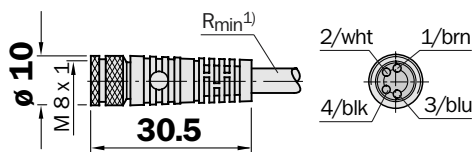

M 8 cable receptacle, 4 pin, angled

Cable ø 5 mm, 4 x 0.25 mm², PVC coating

Type	Order no.	Cable length
DOL-0804-W02M	6 009 871	2 m
DOL-0804-W05M	6 009 873	5 m
DOL-0804-W10M	6 010 755	10 m

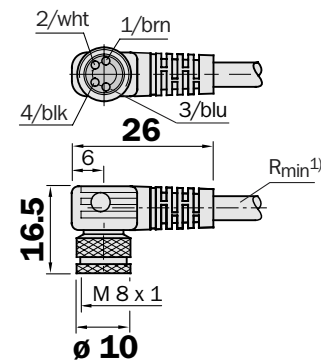

1) Minimum bending radius with dynamic use
 $R_{min} = 20 \times \text{cable diameter}$

Mounting bracket for W 160

Type	Order no.
BEF-W 160	5 305 197

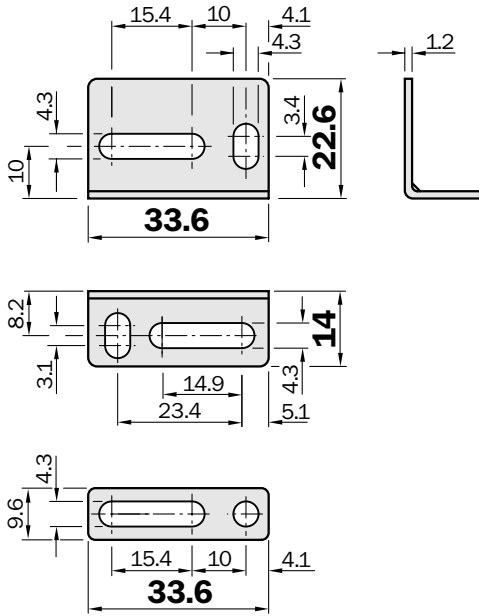

Supplied with WS/WE 160, WL 160 and WT 160.

Mounting bracket for WLL 160

Type	Order no.
BEF-WLL 160	5 305 400

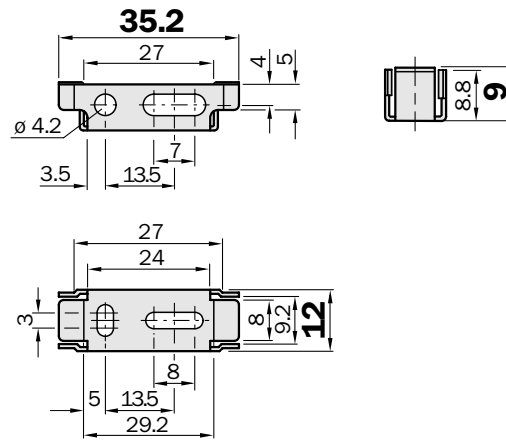

Supplied with WLL 160 and WLL 160T.

Reflector

Type	Order no.
P 250	5 304 812

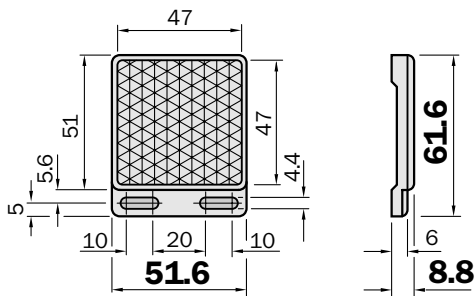

Supplied with WL 160.

Slotted masks for WS/WE 160

Slot width: 1.0 mm*/0.5 mm, 1.0 mm, 2.0 mm

Type	Order no.
BL-160-10*	5 305 196
BL-160-SK	5 310 718

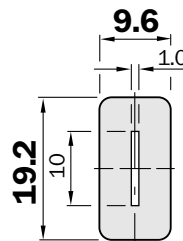

2 pieces supplied with equipment.

Cutting device for fiber-optic cables

Ordering information

Type	Order no.
FC	5 304 141

The cutting device is supplied with the LL 3. Follow the operating instructions in the packaging.

- 1 Template for bending radius R 10 mm, for terminal sleeve \varnothing 1.5 mm and \varnothing 2.5 mm
- 2 Bending radius R 5 mm

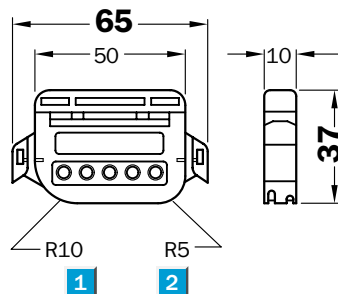

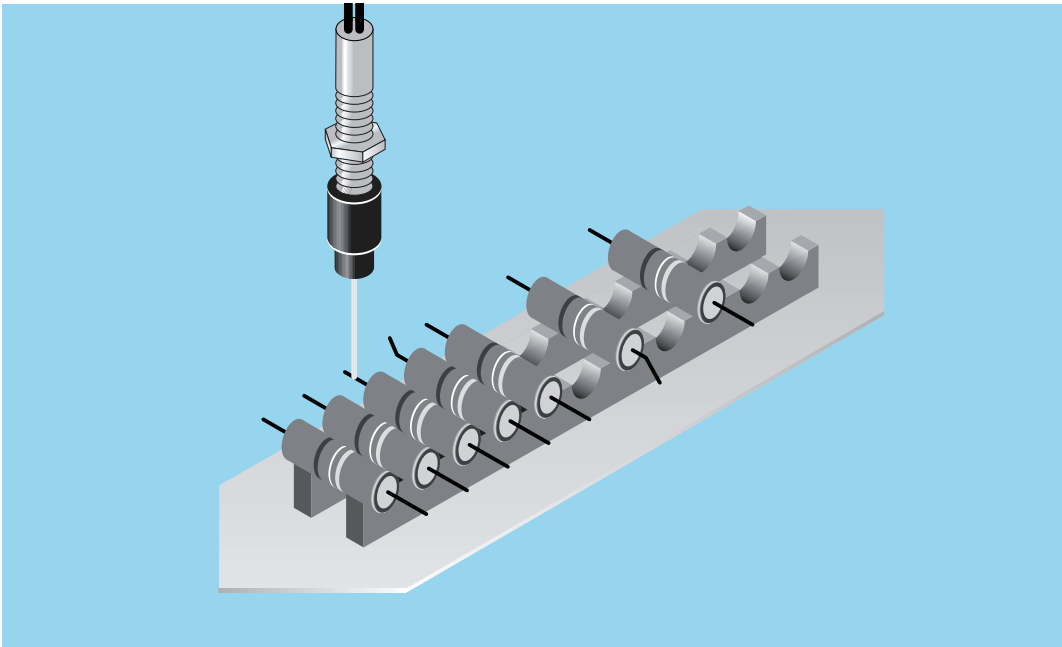

◀ WLL 160 in the fiber-optic cable model detects the thinnest wires without problems in the production of resistances.

▼ Presence check of closures: Lid detection with WT 160 photoelectric proximity switch and clock-pulse with WS/WE 160 through-beam photoelectric switches.

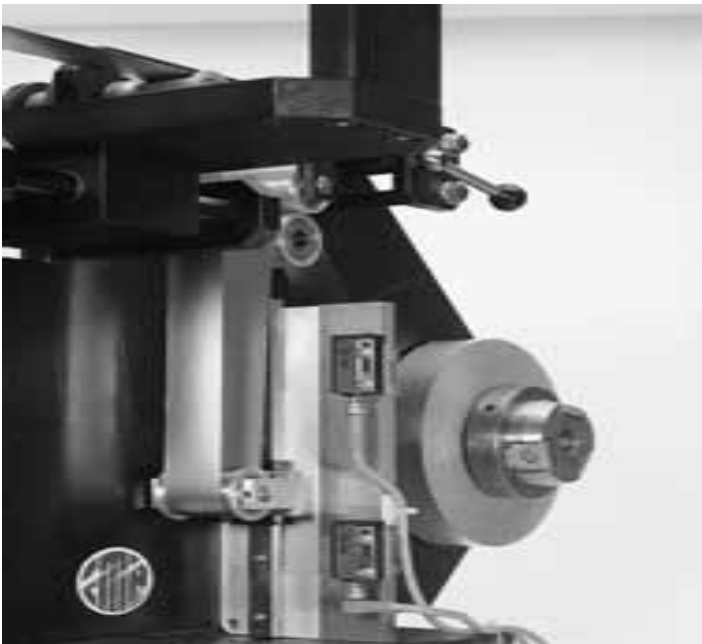

▲ The WT 160 miniature photoelectric proximity switch is used in film processing and for controlling belt tension.

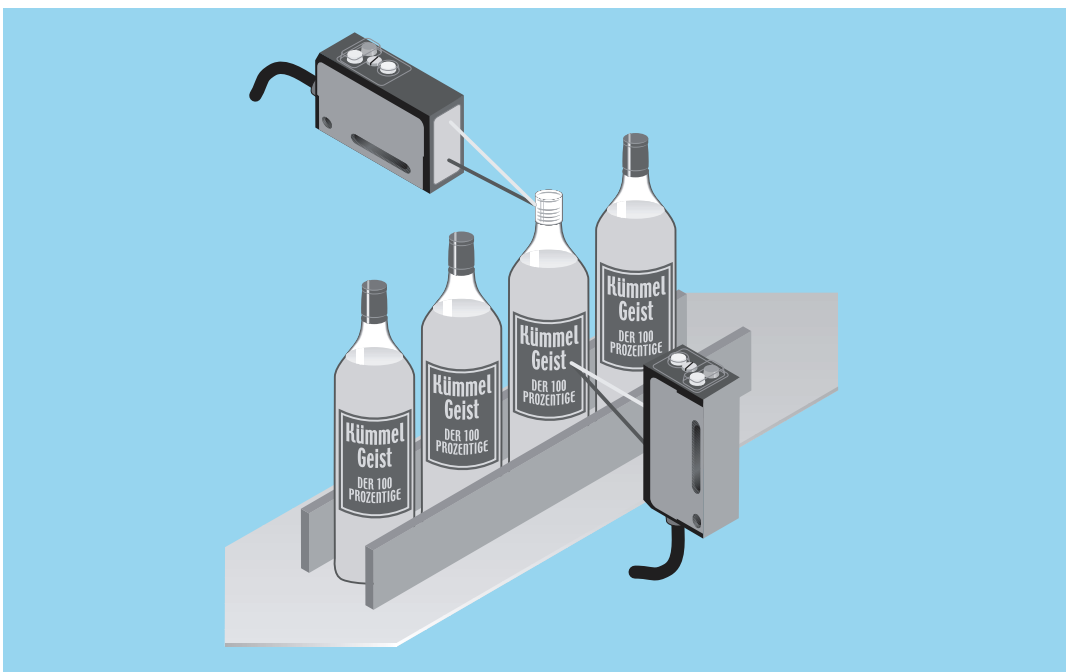

► Closure and lable check with WT 160 photoelectric proximity switch.

Your contacts:

Australia

Phone +61 3 94 97 41 00
008 33 48 02 – toll free
Fax +61 3 94 97 11 87

Austria

Phone +43 2 23 66 22 88-0
Fax +43 2 23 66 22 88-5

Belgium/Luxembourg

Phone +32 24 66 55 66
Fax +32 24 63 31 04

Brazil

Phone +55 11 55 61 26 83
Fax +55 11 55 35 41 53

China

Phone +8 52 27 63 69 66
Fax +8 52 27 63 63 11

Czech Republik

Phone +42 02 578 10 561
Fax +42 02 578 10 559

Denmark

Phone +45 45 82 64 00
Fax +45 45 82 64 01

Finland

Phone +3 58 9-728 85 00
Fax +3 58 9-72 88 50 55

France

Phone +33 1 64 62 35 00
Fax +33 1 64 62 35 77

Germany

Phone +49 2 11 53 01 0
Fax +49 2 11 53 01 100

Great Britain

Phone +44 17 27-83 11 21
Fax +44 17 27-85 67 67

Italy

Phone +39 02 92 14 20 62
Fax +39 02 92 14 20 67

Japan

Phone +8 13 33 58 13 41
Fax +8 13 33 58 05 86

Korea

Phone +82 2 786 66 57/8
Fax +82 2 786 66 59

Netherlands

Phone +31 30 229 25 44
Fax +31 30 229 39 94

Norway

Phone +47 67 56 75 00
Fax +47 67 56 66 10

Poland

Phone +48 22 8 37 40 50
Fax +48 22 8 37 43 88

Singapore

Phone +65 67 44 37 32
Fax +65 68 41 77 47

Spain

Phone +34 93 4 80 31 00
Fax +34 93 4 73 44 69

Sweden

Phone +46 8 6 80 64 50
Fax +46 8 7 10 18 75

Switzerland

Phone +41 4 16 19 29 39
Fax +41 4 16 19 29 21

Taiwan

Phone +88 62 23 65 62 92
Fax +88 62 23 68 73 97

USA

Phone +1(952) 9 41-67 80
Fax +1(952) 9 41-92 87

Representatives and agencies
in all major industrial nations.

SICK